

8601A GENERATOR/SWEEPER

Serial Prefix 1848

This manual applies directly to HP Model 8601A Generator/Sweepers having serial prefix number 1848.

Serial Prefixes Not Listed

For serial prefixes above 1848, a "Manual Changes" sheet is included with this manual. For serial prefixes below 1848, see Section VII, Manual Changes.

Options

For options available see Section I of this manual.

Copyright HEWLETT-PACKARD COMPANY 1969
1400 FOUNTAIN GROVE PARKWAY, SANTA ROSA, CA. 95404, U.S.A.

Manual Part No. 08601-90017
Microfiche Part No. 08601-90018

Printed: APRIL 1980



**HEWLETT
PACKARD**

SAFETY CONSIDERATIONS

Safety Symbols



Instruction manual symbol: the apparatus will be marked with this symbol when it is necessary for the user to refer to the instruction manual in order to protect the apparatus against damage.



Indicates dangerous voltages.



Earth terminal (sometimes used in manual to indicate circuit connected to grounded chassis).

WARNING

The WARNING sign denotes a hazard. It calls attention to a procedure, practice, or the like, which, if not correctly performed or adhered to, could result in injury or loss of life. Do not proceed beyond a WARNING sign until the indicated conditions are fully understood and met.

CAUTION

The CAUTION sign denotes a hazard. It calls attention to an operating procedure, practice, or the like, which, if not correctly performed or adhered to, could result in damage to or destruction of part or all of the equipment. Do not proceed beyond a CAUTION sign until the indicated conditions are fully understood and met.

Operation

CAUTION

BEFORE APPLYING POWER make sure the instrument's ac input is set for the available ac line voltage, that the correct fuse is installed, and that all normal safety precautions have been taken.

Service

The information, cautions, and warnings in this manual must be followed to ensure safe operation and to keep the instrument safe. **SERVICE AND ADJUSTMENTS SHOULD BE PERFORMED ONLY BY QUALIFIED SERVICE PERSONNEL.**

Adjustment or repair of the opened instrument with the

ac power connected should be avoided as much as possible and, when unavoidable, should be performed only by a skilled person who knows the hazard involved.

Capacitors inside the instrument may still be charged even though the instrument has been disconnected from its source of supply.

Make sure only fuses of the required current rating and type (normal blow, time delay, etc.) are used for replacement. Fuse requirements are indicated on the instrument's rear panel. Do not use repaired fuses or short-circuit fuse holders.

Whenever it is likely that the protection has been impaired, make the instrument inoperative and secure it against any unintended operation.

WARNING

If this instrument is to be energized through an auto-transformer (for voltage reduction), make sure the common terminal is connected to the earthed pole of the power source.

BEFORE SWITCHING ON THE INSTRUMENT, the protective earth terminal of the instrument must be connected to the protective conductor of the (mains) power cord. The mains plug shall only be inserted in a socket outlet provided with protective earth contact. The protection action must not be negated by using an extension cord (power cable) without a protective grounding conductor. Grounding one conductor of a two-conductor outlet is not sufficient protection.

Any interruption of the protective (grounding) conductor, inside or outside the instrument, or disconnection of the protective earth terminal is likely to make this instrument dangerous. Intentional interruption of the earth ground is prohibited. Whenever it is likely that the protection has been impaired, the instrument must be secured against any unintended operation.

Servicing this instrument often requires that you work with the instrument's protective covers removed and with ac power connected. Be very careful; the energy at many points in the instrument may, if contacted, cause personal injury.

SECTION I GENERAL INFORMATION

1-1. INTRODUCTION

1-2. This manual contains installation, operation and service information for the HP Model 8601A, shown in Figure 1-1. Complete specifications for the Model 8601A Generator/Sweeper are given in Table 1-1.

1-3. INSTRUMENTS COVERED BY MANUAL

1-4. Each Model 8601A is identified by a two-section serial number on the rear of the instrument. The first section is separated from the second section by a dash or a letter. The first section of numbers is a serial prefix number used to document changes and the second set of numbers is an identification number unique to each instrument.

1-5. All instruments with the same serial prefix are the same. The groups of instruments to which this manual applies directly are identified on the title page. For instruments with lower serial prefix numbers than those listed, make manual changes listed in Section VII. For instruments with higher serial prefix numbers, a Manual Changes sheet is included, describing the required changes. If a change sheet is missing, the information can be supplied by any Hewlett-Packard sales and service office (see list at the rear of this manual).

1-6. DESCRIPTION

1-7. The Model 8601A Generator/Sweeper is a rf signal source with both CW and wide band swept frequency capabilities in the 0.1 to 110 MHz range. In the CW mode, residual fm is less than 50 Hz rms from 0.1 to 11 MHz, and less than 500 Hz rms from 1.0 to 110 MHz (including line-related components). Harmonic outputs are 35 dB below the carrier; spurious and non-harmonic outputs are 40 dB below the carrier. Swept-frequency measurements of all or any part of the 0.1 to 11 MHz or 1.0 to 110 MHz bands are possible by selection of FULL, VIDEO, or SYMMETRICAL sweep modes. Internal and external frequency modulation is also possible for narrow-band sweep operations or remote tuning.

1-8. The FULL sweep covers the whole 0.1 to 11 MHz or 1.0 to 110 MHz band. The VIDEO sweep is from the bottom of the selected range up to the frequency selected by front panel fre-

quency control. The SYMMETRICAL sweep operation sweeps above and below the CW frequency selected by front panel frequency control. The symmetrical sweep width is calibrated from 0.01 to 1.0 MHz for the 0.1 to 11 MHz band, and from 0.1 to 10 MHz for the 1.0 to 110 MHz band. A sweep width vernier adjusts the sweep width from the calibrated position to zero.

1-9. The calibrated rf output is variable from +20 to -110 dBm (2.23V to 1 μ Vrms) into 50 ohms by use of the OUTPUT LEVEL and VERNIER controls. Other outputs include a 0.1 to 11 MHz auxiliary output on both bands to permit use of a low-frequency counter for frequency monitoring; a 0 to +7V sweep output for horizontal drive of oscilloscopes and X-Y recoders; and an uncalibrated rf output for phase-lock operations.

1-10. OPTIONS AVAILABLE

1-11. Options 001 and 002 modify the 8601A to provide variable internal am and fm. FM deviation is variable from 0 to 1000 kHz for Option 001. FM deviation is variable from 0 to 30 kHz for Option 002. Amplitude modulation is variable from zero to 30% with either option. When the front panel MOD pushbutton is depressed, the RF output meter indicates modulation level.

NOTE

Front panel meter is usable as am or fm monitor with externally applied modulation.

1-12. Option 003 reduces the external fm sensitivity to 100 kHz/volt \pm 5%, high range, and 10 kHz/volt \pm 5%, low range.

1-13. Option 004 adds a rear panel auxiliary output in parallel with the standard front panel auxiliary output.

1-14. Option 005 modifies the 8601A to provide a 400 Hz internal modulation frequency rate.

1-15. Option 006 modifies the 8601A to provide 22.5 kHz peak internal fm deviation, high range, and 2.25 kHz peak deviation, low range.

1-16. Option 007 enables the 8601A to be used as a tracking generator by substituting an external

signal for the 8601A vto (Internal Voltage Tuned Oscillator) signal. This capability allows the 8601A to be used with the HP Model 8553 110 MHz Spectrum Analyzer to provide displays of log amplitude versus frequency with 70 dB display range for sweep widths from 500 kHz to 100 MHz. To obtain this operation, the first lo (local oscillator) output of the Spectrum Analyzer is taken directly to an 8601A rear panel input by removing the shorting cable that is used for normal 8601A operation.

1-17. Options 008, 009, and 010 change the output meter, attenuator assembly, RF output cable, and connector to provide the 8601A with a 75 ohm output impedance. The dBm scale on the meter is moved to indicate dBm into 75 ohms. For Option 008, the output connector is a standard BNC connector. For option 009, the output connector is a TNC connector. For Option 010, the output connector is the Western Electric type.

1-18. Option 011 provides variable fm with peak deviation of 0 to 30 kHz and 0 to 10 kHz. A

dual-scale front panel meter monitors peak deviation.

1-19. Option 012 provides internal Fm with deviation variable from 0 to 110 kHz (Option 001). It also provides external FM sensitivity of 100 kHz/Volt $\pm 5\%$, high range, and 10 kHz/Volt $\pm 5\%$, low range (Option 003).

Option 012 also has a special line filter and a special line cord. The Option 012 configuration is designed for 115 volt operation only and has been ruggedized to meet military mechanical specifications. The color of the Model 8601A Option 012 is Navy gray with plain aluminum panels.

1-20. RECOMMENDED TEST EQUIPMENT

1-21. Equipment required to maintain the Model 8601A is listed in Table 1-2. Other equipment may be substituted if it meets or exceeds the critical specifications listed in the table.

Table 1-1. Specifications (1 of 2)

FREQUENCY CHARACTERISTICS		
Coverage: Low range, 0.1 – 11 MHz; high range, 1 – 110 MHz.	SYM 0, Sweep: Less than 100 Hz rms, low range; <1 kHz rms, high range.	
Accuracy (in CW, stop frequency of VIDEO sweep, and center frequency of SYMMETRICAL sweep): Low range, $\pm 1\%$ of frequency ± 10 kHz. High range, $\pm 1\%$ of frequency ± 100 kHz.	Incidental FM with 30% AM: CW: negligible. SYM 0, Sweep: <100 Hz peak, low range; <1 kHz peak, high range.	
Settability: Vernier settability, $\pm 0.01\%$; range, $\pm 0.1\%$; coarse settability using frequency control is 5 kHz, low range; 50 kHz, high range.	Residual AM: AM noise modulation index (rms, 10 kHz bandwidth) is < -50 dB. (Typically -60 dB at 25°C .)	
Linearity: $\pm 0.5\%$ of maximum sweep width.	Incidental AM: Incidental AM modulation index is < -55 dB with 75 kHz deviation.	
Stability in CW: 50 ppm $+1$ kHz/10 min. high range after two hour warm up. 50 ppm $+100$ Hz/10 min. low range after two hour warm up. 300 ppm $+3$ kHz/ $^\circ\text{C}$, high range. 300 ppm $+300$ Hz/ $^\circ\text{C}$, low range. 10 ppm/V line voltage change.		
Harmonics and Spurious Signals (CW above 250 kHz, output levels below $+10$ dBm): Harmonics at least 35 dB below carrier (33 dB below carrier for options 008, 009 and 010). Spurious signals at least 40 dB below carrier.	OUTPUT CHARACTERISTICS	
Residual FM: Noise in a 10 kHz bandwidth including line related components. (Dominant component of RESIDUAL FM is noise.)	Level: $+20$ to -110 dBm ($+18$ to -112 dBm for Options 008, 009 and 010). 10 dB steps and 13 dB vernier provide continuous settings over entire range. Meter monitors output in dBm and rms volts into 50Ω (75Ω for Options 008, 009 and 010).	
CW: < 50 Hz rms, low range; < 500 Hz rms, high range.	Accuracy: ± 1 dB accuracy for any output level from $+13$ dBm to -110 dBm.	
	Flatness: ± 0.25 dB over full range, ± 0.1 dB over any 10 MHz portion. ($+10$ dBm step or below)	
	Impedance: 50Ω , SWR < 1.2 on 0 dBm step and below.	
	RF Leakage: Low leakage permits receiver sensitivity measurements down to 1 microvolt.	

Table 1-1. Specifications (2 of 2)

SWEEP CHARACTERISTICS	
<p>Full: Approximately 0.1 – 11 MHz and 1 – 110 MHz independent of dial setting.</p> <p>Video: Sweep extends from low end of range to frequency dial setting. Start frequency accuracy is $\pm 1\%$ of stop frequency, or ± 10 kHz, low range; ± 100 kHz high range, whichever is greater.</p> <p>Symmetrical: Center frequency may be tuned to any point on either range.</p> <p>Sweep Width: 0 – 1 MHz low range; 0 – 10 MHz high range. There are five calibrated sweep width positions as well as an uncalibrated vernier to provide continuous adjustment.</p> <p>Sweep Width Accuracy: $\pm 2\%$ of sweep width or ± 1 kHz on low range; $\pm 2\%$ of sweep width or ± 10 kHz on high range.</p> <p>Sweep Speeds: Fast, typically 3 to 60 sweeps per second, variable. Slow, typically 3 to 60 seconds per sweep, variable. Manual, continuous tuning over preset limits.</p> <p>Trigger Modes: Manual trigger with reset, line-synchronized, or free running.</p>	<p>External AM: Zero to 50%, up to 400 Hz. Zero to 30%, up to 1 kHz. Applied through external AM input on front panel. Sensitivity typically 2V peak/10% modulation index at 400 Hz (10 – 50% AM).</p>
AMPLITUDE MODULATION	
<p>Internal AM: 30% $\pm 5\%$ at 1 kHz, less than 3% distortion. Typically $< 1\%$ distortion for output readings on upper half of meter scale.</p>	<p style="text-align: center;">Note</p> <p>For Option 005, rate is 400 Hz.</p>
PERFORMANCE CHARACTERISTICS	
AUXILIARY OUTPUTS	
<p>Front Panel: Sweep Output: approximately 0 to +7 volts. Auxiliary Output: always 0.1 – 11 MHz for low frequency counter monitoring.</p> <p>Rear Panel: Sweep inhibit; stops sweep when grounded. Uncalibrated RF output: -12 dBm minimum, unmodulated. VTO output: 200.1 – 310 MHz, output level -25 dBm minimum. Blanking: -4 volt pulse concurrent with RF blanking.</p> <p>Stability in CW</p>	<p>External FM: Sensitivity: 0.5 MHz per volt $\pm 5\%$, low range; 5 MHz per volt $\pm 5\%$, high range; negative polarity.</p> <p>Deviations to the band edges are possible for rates to 100 Hz; voltage to frequency linearity is $\pm 0.5\%$, allowing remote frequency programming. FM rates to 10 kHz are obtainable with less linearity and accuracy.</p>
CRYSTAL CALIBRATOR	
<p>Internal 5 MHz crystal allows single frequency calibration to $\pm 0.01\%$ at any multiple of 5 MHz.</p>	
GENERAL	
<p>Power: 115V $\pm 10\%$, 400 Hz; or 115 or 230V $\pm 10\%$, 50–60 Hz; approximately 50 VA (50 watts).</p> <p>Weight: Net, 21 lbs. (9.5 kg).</p> <p>Dimensions: 7-25/32 in. wide, 6-3/32 in. high, 16-3/8 in. deep (190 x 155 x 416 mm).</p>	

Table 1-2. Recommended Test Equipment (1 of 3)

Instrument Type	Critical Specifications	Suggested Model	Use (Note 1)
Counter/Marker Generator	Frequency Range: 0.1 – 12 MHz Accuracy: 0.1% of frequency Input Impedance: 500K ohms	HP 8600A	P, A, T
Digital Voltmeter	Voltage Range: 0 – 75 VDC to +25 V Accuracy: $\pm 0.16\%$ of voltage Input Impedance: > 100 K ohms	HP 3439A/3443A	P, A

Table 1-2. Recommended Test Equipment (2 of 3)

Instrument Type	Critical Specifications	Suggested Model	Use (Note 1)
RF Detector	Frequency Range: 0.1 – 110 MHz Frequency Response: $< \pm 0.1$ dB over any 10 MHz range Output Polarity: Negative Input Impedance: 50 ohms (note 2)	HP 8471A (note 2)	P, A, T
Electronic Counter	Frequency Range: dc to 50 MHz Sensitivity: 100 mV Gate Time: 1 μ S (Time Base)	HP 5245L	P
Frequency Meter and FM Discriminator	Input Frequency Range: 10 MHz Bandwidth: 3 Hz to 2 MHz Discriminator Output: Linearity: $\pm 0.5\%$ Residual FM Noise: All components 43.3 dB below full scale output level Output Range: Adjustable from 100 kHz/volt to 10 MHz volt Output Filtering (see Note 4)	HP 5210A and 2 MHz low-pass filter (Note 3)	P, A
Oscilloscope	Bandwidth: DC to 20 MHz Vertical Sensitivity: 5 mV/div to 1 volt/div Input Impedance: 100K ohms External and internal horizontal sweep capability	HP 180A/1803A/1820A	P, A, T
110 MHz Spectrum Analyzer	Frequency Range: 1 kHz – 110 MHz Input Measurement Range: -50 to $+10$ dBm in 50 ohms Amplitude Calibration: 1. 10 dB/div 2. Accuracy: ± 1 dB	HP 140T/8552/8553	P, A, T
400 MHz Spectrum Analyzer	Frequency Range: 10 MHz – 400 MHz Input Measurement Range: -50 to $+20$ dBm Amplitude Calibration: 1. 10 dB/div 2. Accuracy: ± 1 dB	HP 140T/8552/8555	P, A, T
1 kHz Amplifier	Frequency Range: 1 kHz Amplification: > 10 dB in 50 ohms	HP 461A or 466A	P
DC Power Supply	DC Range: 0.05 to $+10.9$ VDC Output Impedance: < 0.5 ohms	HP 6215A	P, A
Signal Generator	Frequency Range: 0.2 to 110 MHz Output Level: -10 dBm into 50 ohms Residual FM: 1. < 50 Hz up to 110 MHz 2. < 20 Hz up to 11 MHz	HP 606A and 608C	P
Audio Oscillator	Frequency Range: 100 Hz to 10 kHz Output Level: 10 volts into 600 ohms	HP 200CD	P, A
50 Ohm Termination (Note 5)	Frequency Range: 0.1 to 110 MHz Impedance: 50 ohms $\pm 5\%$ Connector: BNC plug	HP Part No. 1250-0207	P, A

Table 1-2. Recommended Test Equipment (3 of 3)

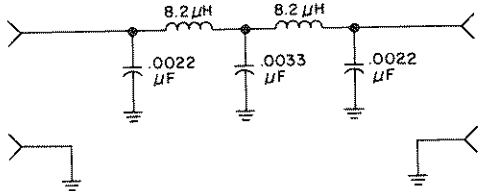
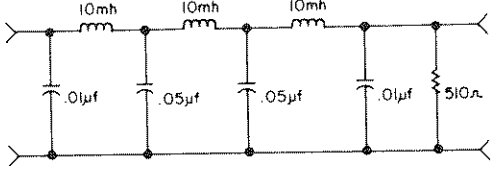
Instrument Type	Critical Specifications	Suggested Model	Use (Note 1)
RMS Voltmeter	Frequency Range: DC to 80 kHz Input Range: 7 mV to 1 Vrms Input Impedance: >100K ohms	HP 3400A	P, A
50 Ohm Termination (Note 5)	Frequency Range: 0.1 to 110 MHz Impedance: 50 ohms $\pm 5\%$ Connector: SMC Coaxial Plug	HP Part No. 1250-0839	A, T
Minimum Loss Pad	Frequency Range: 0.1 to 110 MHz 75 ohm to 50 Ohm Transition Connector: BNC plug/BNC jack	Texscan Corporation, Model ZM-57 (Note 6)	P, A
Adapters 1. BNC Tee 2. Subminiature-to-BNC	1. BNC plug and two BNC jacks Impedance: 50 ohms 2. BNC jack to SMC plug Impedance: 50 ohms	HP Part No. 1250-0781 HP Part No. 1250-0832	P A
Balanced Mixer	Frequency Range: 6 to 60 MHz Inputs: -10 dBm to +10 dBm	HP 10514A or 10534A	P, A
2 MHz low pass filter	 <p>Cutoff Frequency: 2 MHz Insertion Loss: Above 2 MHz: >6 dB Above 10 MHz: >40 dB</p>	<p>Suggested Part Types: 8.2 μH $\pm 10\%$ (HP Part No. 9140-0105) 0.0033 μF $\pm 10\%$ (HP Part No. 0160-0155) 0.0022 μF $\pm 10\%$ (HP Part No. 0160-0154)</p>	
10 kHz Low Pass Filter		<p>Suggested Part Types: 10 mH $\pm 10\%$ (HP Part No. 9140-0131) .01 μF $\pm 10\%$ (HP Part No. 0160-0161) .05 μF $\pm 10\%$ (HP Part No. 0160-3361) 510 Ohm $\pm 1\%$ (HP Part No. 0757-0416)</p>	
<p style="text-align: center;">Notes</p> <ol style="list-style-type: none"> P = Performance tests; A = Adjustment procedures; T = Troubleshooting. For 8601A Options 008, 009 and 010: the HP-8471A, Option 005, is required. 2 MHz low pass filter construction is shown at end of table. 10 kHz and 100 kHz filtering of output signal is required for some tests. The HP Model 10531A Filter Kit is recommended. For 8601A Options 008, 009 and 010: a 75 ohm termination is required. This termination could be a 50-to-75 ohm matching transformer used with a standard 50 ohm termination. (A typical matching transformer is the North Hills Electronics Company's Model 11061.) Texscan Corporation, 2446 North Shadeland Avenue, Indianapolis, Indiana, 46219. 			



SECTION II INSTALLATION

2-1. INITIAL INSPECTION

2-2. Mechanical Check

2-3. If external damage to the shipping carton is evident, ask the carrier's agent to be present when the instrument is unpacked. Inspect the instrument for mechanical damage. Also, check the cushioning material for signs of severe stress.

WARNING

BEFORE THE INSTRUMENT IS SWITCHED ON, its protective earth terminals must be connected to the protective conductor of the main power cable. The main plug shall be inserted only in a socket outlet provided with a protective earth contact. DO NOT negate the earth-grounding protection by the use of an extension cable, power cable, or autotransformer that does not have a protective ground conductor. Failure to ground the instrument properly can result in personal injury.

To avoid hazardous electrical shock, do not perform electrical tests when there are signs of shipping damage to any portion of the outer enclosure (covers, panels, meters.)

2-4. Electrical Check

2-5. The electrical performance of the Model 8601A should be verified as soon as possible upon receipt. Performance tests suitable for incoming inspection are given in Section IV, Performance Tests. Equipment required for performance tests is listed in Table 1-2.

2-6. Claims for Damage

2-7. Before shipment this instrument was inspected and found free of electrical and mechanical defects. If the Model 8601A is mechanically damaged in transit, notify the carrier and the nearest Hewlett-Packard sales and service office immediately. Retain the shipping carton and packing material for the carrier's inspection. The Hewlett-Packard sales and service office will arrange for replacement or repair of your instrument without waiting for claim settlements against the carrier.

2-8. PREPARATION FOR USE

2-9. Power Requirements

2-10. The Hp Model 8601A Generator/Sweeper requires a power source of 115V $\pm 10\%$, 400 Hz; or 115 or 230 volts ac $\pm 10\%$, 50 to 60 Hz, single phase, which can supply at least 50VA (50 watts).

2-11. 115/230 Volt Operation

CAUTION

To avoid damage to the instrument, set the 115/230 volt slide switch for the line voltage to be used and insert proper line fuse before connecting the power cable.

2-12. A rear panel two-position slide switch permits operation from either a 115 or 230 volt power source. The number visible on the switch indicates the line voltage for which the instrument is connected. To prepare the Model 8601A for operation, position the 115/230 volt slide switch so that the number visible corresponds to the available line voltage, and install a line fuse of correct rating.

2-13. Three-Conductor Power Cable

2-14. **Power Cable.** The instrument is equipped with a three-wire power cable in accordance with international safety standards. When connected to an appropriate power line outlet, the cable grounds the instrument cabinet. Table 2-1 includes illustrations of the main plug styles available on power cables supplied with Hewlett-Packard instrument. The part numbers are for complete power cables.

2-15. Operating Environment

2-16. The temperature of surrounding air must not exceed 55°C (131°F). Clearances for ventilation should be at least three to four inches at the rear of the cabinet and two to three inches at the sides. The clearances provided by the plastic feet in bench stacking are adequate for the top and bottom cabinet surfaces.

2-17. Bench Operation

2-18. The Model 8601A cabinet has plastic feet and a foldaway tilt stand for convenience in bench operation. The tilt stand permits inclining the instrument for ease in reading the meter. The plastic feet are shaped to provide clearance for air circulation and to make HP half-width modular instruments such as the Generator/Sweeper self-aligning when stacked.

2-19. REPACKAGING FOR SHIPMENT**2-20. Original Packing Materials**

2-21. Containers and packing materials identical to those used by the factory are available through your nearest Hewlett-Packard sales and service office (see list at the rear of this manual). If the Model 8601A is being returned for servicing and repair, attach a tag indicating type of service, return address, and full instrument serial number. Also mark the box FRAGILE to assure careful handling. In any correspondence regarding your instrument, refer to the instrument by its full HP model number and full serial number.

2-22. Other Packing Materials

2-23. The following general instructions should be followed for repackaging with commercially available materials:

1. Wrap the instrument in heavy paper or plastic. (If shipping to a Hewlett-Packard service office or center, attach a tag indicating the type of service required, return address, full HP model number, and full serial number.)



2. Use a strong shipping container. A double-wall carton made of 350 pound test material is adequate.

3. Use enough shock-absorbing material (three to four inch layer) around all sides of the instrument to provide firm cushion and prevent movement inside the container. Protect the control panel with cardboard.

4. Seal the shipping container securely.

5. Mark the shipping container FRAGILE to assure careful handling.

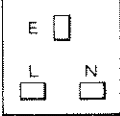
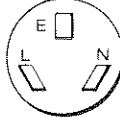
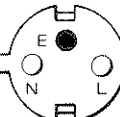
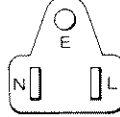
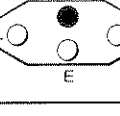
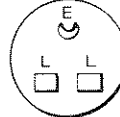
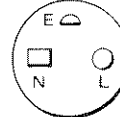
Table 2-1. AC Power Cables Available

Plug Type	Cable HP Part Number	C D	Plug Description	Cable Length (inches)	Cable Color	For Use In Country
<p>250V</p> 	8120-1351 8120-1703	0 6	Straight*BS1363A 90°	90 90	Mint Gray Mint Gray	United Kingdom, Cyprus, Nigeria, Rhodesia, Singapore
<p>250V</p> 	8120-1369 8120-0696	0 4	Straight*NZSS198/ASC112 90°	79 87	Gray Gray	Australia, New Zealand
<p>250V</p> 	8120-1689 8120-1692	7 2	Straight*CEE7-Y11 90°	79 79	Mint Gray Mint Gray	East and West Europe, Saudi Arabia, Egypt So. Africa, India (unpolarized in many nations)
<p>125V</p> 	8120-1348 8120-1398 8120-1754 8120-1378 8120-1521 8120-1676	5 5 7 1 6 2	Straight*NEMA5-15P 90° Straight*NEMA5-15P Straight*NEMA5-15P 90° Straight*NEMA5-15P	80 80 36 80 80 36	Black Black Black Jade Gray Jade Gray Jade Gray	United States, Canada, Japan (100V or 200V), Mexico, Philippines, Taiwan
<p>250V</p> 	8120-2104	3	Straight*SEV1011 1959-24507 Type 12	79	Gray	Switzerland
<p>250V</p> 	8120-0698	6	Straight*NEMA6-15P			United States, Canada
<p>220V</p> 	8120-1957 8120-2956	2 3	Straight*DHCK 107 90°	79 79	Gray Gray	Denmark
<p>250 V</p> 	8120-1860	6	Straight*CEE22-VI (Systems Cabinet use)			

*Part number shown for plug is industry identifier for plug only. Number shown for cable is HP Part Number for complete cable including plug.
E = Earth Ground; L = Line; N = Neutral



SECTION III OPERATION

3-1. INTRODUCTION

3-2. This operating section explains the function of the controls and indicators of the Model 8601A Generator/Sweeper. It also describes typical operating modes and operator maintenance such as fuse and indicator lamp replacement.

3-3. PANEL FEATURES

3-4. Front and rear panel features are described in Figures 3-1 and 3-2. Description numbers match the numbers on the illustration.

3-5. OPERATOR'S CHECK

3-6. The operator's check (Figure 3-3) is supplied to allow the operator to make a quick check of the main instrument functions prior to use. If the correct indications are not obtained, perform the performance tests in Section IV to determine if the instrument is working correctly.

3-7. OPERATING INSTRUCTIONS

3-8. Figure 3-4 describes general operating procedures and the crystal calibration procedure is described in Figure 3-5. Procedure steps are numbered to correspond to related controls in the photographs.

3-9. General Operating Information

3-10. The FULL sweep covers the full 0.1 to 11 MHz or 1.0 to 110 MHz range. The VIDEO sweep is from the bottom of the band up to the frequency indicated by the front panel tuning controls. The SYMMETRICAL sweep operation sweeps upward, centered on the CW frequency indicated by the front panel tuning controls. The symmetrical sweep width is calibrated and can be varied from 1.0 to 0 MHz on range 11 and from 10 to 0 MHz on range 110. The zero sweep width position disables the sweep and is reserved for fm operation.

3-11. Sweep speed is varied with the FAST/SLOW/MANUAL switch. The control adjacent to this switch serves as a sweep speed vernier in the FAST and SLOW positions and as a manual

sweep control in the MANUAL position. Sweep speed adjustment range is from approximately 3 to 60 sweeps/second in the FAST position and from approximately 3 to 60 seconds/sweep in the SLOW position.

3-12. Sweep triggering is selected with the TRIG/LINE/FREE switch. In the TRIG position, the sweep is started by depressing the trigger button. Retrace occurs automatically or sweep may be terminated manually by depressing the trigger button a second time. In the LINE position, the sweep repetition rate is synchronized with the line frequency. In the FREE position, the sweep repetition rate is free running.

3-13. The OUTPUT LEVEL and VERNIER controls provide continuous adjustment of the rf output level from +20 to -110 dBm. The output level is calibrated when the VERNIER is adjusted for a 0 dBm reading on the meter.

3-14. FM and Symmetrical Operation

3-15. Internal fm (1 kHz rate) may be used in CW or any sweep mode. Internal fm produces a frequency deviation of 7.5 kHz $\pm 5\%$ peak on range 11, and 75 kHz $\pm 5\%$ on range 110. The internal fm rate is 1 kHz. External fm is available for any SWEEP mode, but not useable in CW mode. External fm deviation and rate limits are shown in Figure 3-8.

3-16. During fm and symmetrical sweep operations, special care should be taken to operate within the specified 8601A frequency limits. If operation is set for frequencies below 0.1 MHz on range 11 or 1.0 MHz on range 110, search circuit activates preventing the output frequency from going below the lower limit of the band. Search operation is indicated by jitter on the oscilloscope display of the detected RF output when the 8601A is required to operate below the lower limit of the band.

3-17. Amplitude Modulation Operation

3-18. Internal or external am can be used in CW or any sweep mode. Internal modulation is 30%

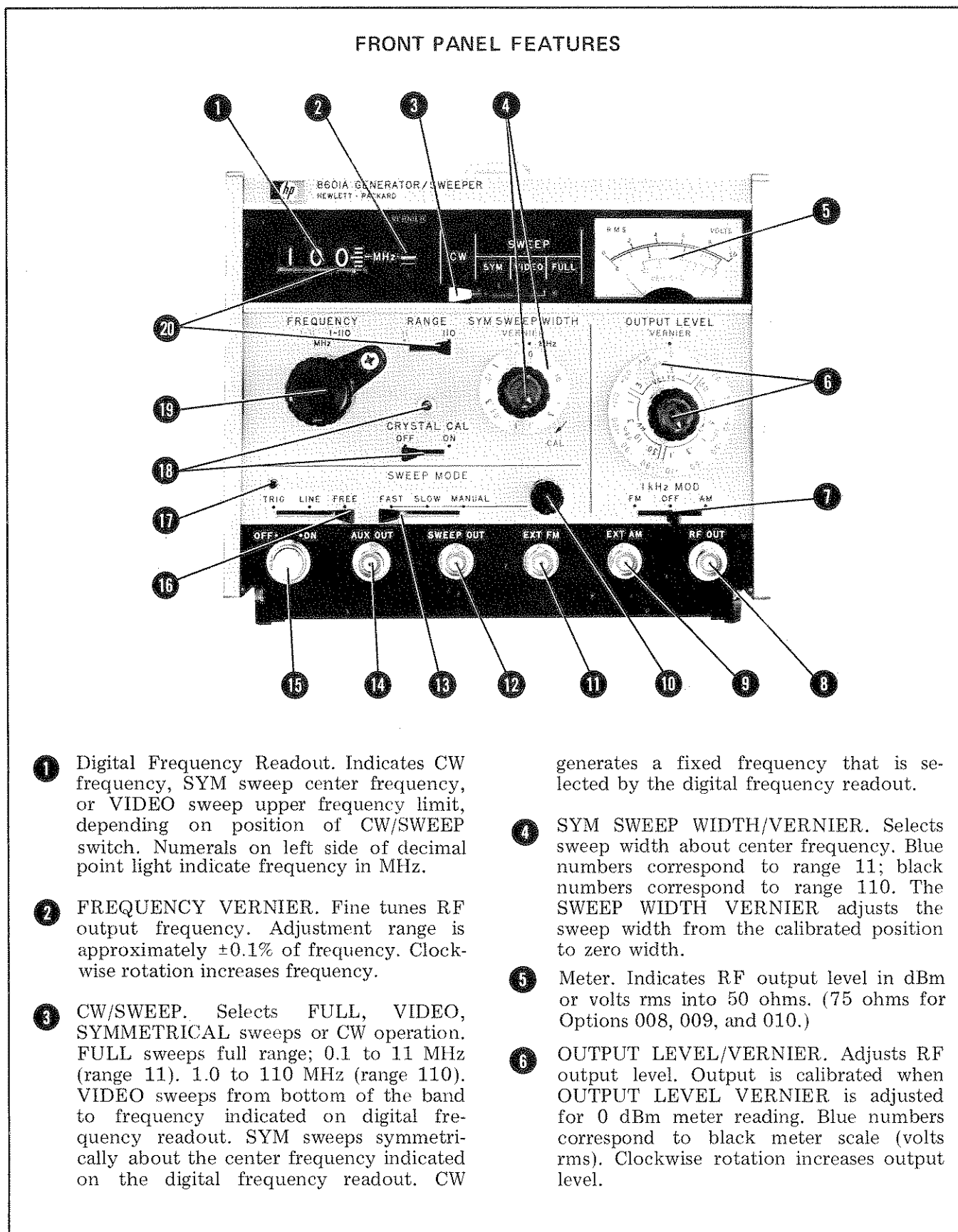

- 1 Digital Frequency Readout. Indicates CW frequency, SYM sweep center frequency, or VIDEO sweep upper frequency limit, depending on position of CW/SWEEP switch. Numerals on left side of decimal point indicate frequency in MHz.
- 2 FREQUENCY VERNIER. Fine tunes RF output frequency. Adjustment range is approximately $\pm 0.1\%$ of frequency. Clockwise rotation increases frequency.
- 3 CW/SWEEP. Selects FULL, VIDEO, SYMMETRICAL sweeps or CW operation. FULL sweeps full range; 0.1 to 11 MHz (range 11). 1.0 to 110 MHz (range 110). VIDEO sweeps from bottom of the band to frequency indicated on digital frequency readout. SYM sweeps symmetrically about the center frequency indicated on the digital frequency readout. CW

- 4 SYM SWEEP WIDTH/VERNIER. Selects sweep width about center frequency. Blue numbers correspond to range 11; black numbers correspond to range 110. The SWEEP WIDTH VERNIER adjusts the sweep width from the calibrated position to zero width.
- 5 Meter. Indicates RF output level in dBm or volts rms into 50 ohms. (75 ohms for Options 008, 009, and 010.)
- 6 OUTPUT LEVEL/VERNIER. Adjusts RF output level. Output is calibrated when OUTPUT LEVEL VERNIER is adjusted for 0 dBm meter reading. Blue numbers correspond to black meter scale (volts rms). Clockwise rotation increases output level.

Figure 3-1. Front Panel Controls, Connectors and Indicators (1 of 2)

FRONT PANEL FEATURES

- 7 1 kHz MOD. Turns on either internal frequency or amplitude modulation of RF output. In AM position output is amplitude modulated at 30%, 1 kHz rate. In FM position output is frequency modulated at 7.5 kHz deviation, 1 kHz rate (75 kHz peak deviation on high range).
- 8 RF OUT. Calibrated RF output (into 50 ohms).
- 9 EXT AM. Input for external amplitude modulating signals (see Figure 3-9).
- 10 Manual/Sweep Speed Control. Manual sweep control in MANUAL mode; sweep speed vernier in FAST and SLOW modes. Clockwise rotation sweeps upward across band (in MANUAL) or increases sweep speed (in SLOW and FAST).
- 11 EXT FM. Input for modulation signals at rates up to 10 kHz (see Figure 3-8). Modulation (deviation) sensitivity is 5 MHz/volt in range 110; 0.5 MHz/volt in range 11.
- 12 SWEEP OUT. Output ramp voltage concurrent with RF sweep. Output is approximately 0 to +7V in all sweep modes.
- 13 FAST/SLOW/MANUAL. Selects sweep speed or manual operation.
- 14 AUX OUT. Auxiliary output used for frequency monitoring. Output level is approximately 0.5V p-p into 200 ohms. Output frequency is 0.1 to 11 MHz on both ranges. (Range 110 output is divided by ten.) Provides about a -5 volt DC level for decimal point movement when using HP Model 8600A for frequency measurement.
- 15 ON/OFF. Depressing turns instrument on or off; lamp lights when instrument is on.
- 16 TRIG/LINE/FREE. Selects sweep trigger. In TRIG position, sweep is started by depressing trigger button. Retrace occurs automatically, or sweep can be terminated manually by depressing trigger button a second time. In LINE position, sweep repetition rate is synchronized with line frequency. In FREE position, sweep is derived from internal sweep generator and system is free running.
- 17 Trigger Pushbutton. Initiates single sweep each time it is pressed momentarily when TRIG/LINE/FREE switch is in TRIG position (SYM, VIDEO or FULL SWEEP modes).
- 18 Crystal Cal. Activates 5 MHz calibrator circuit. Output beat-signals at 5 MHz intervals are used to calibrate single or very slow swept frequency readout (refer to Figure 3-5).
- 19 FREQUENCY. Selects CW frequency, SYMMETRICAL sweep center frequency, or VIDEO sweep upper frequency limit, depending on position of CW/SWEEP switch. Clockwise rotation increases frequency.
- 20 RANGE. Selects desired frequency range. Decimal point indicator light is automatically placed for correct frequency readout (MHz).

Figure 3-1. Front Panel Controls, Connectors and Indicators (2 of 2)

REAR PANEL FEATURES

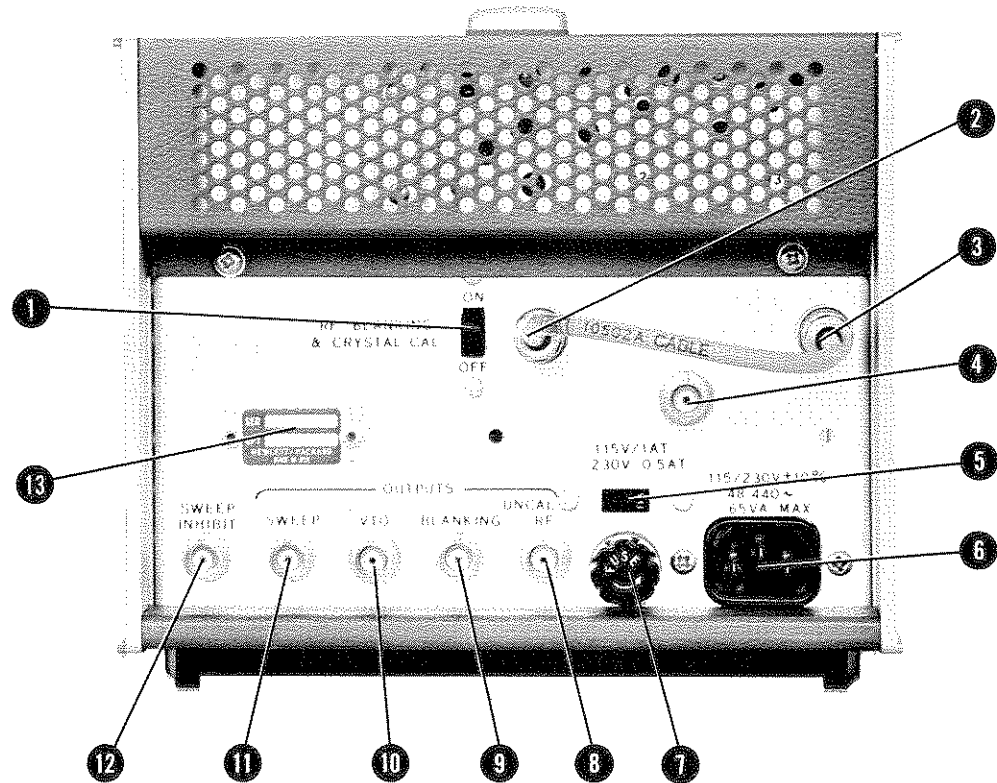

- ① RF BLANKING/CRYSTAL CAL. Enables and disables RF blanking and crystal calibrator circuit.
- ② VTO Output (Option 007 only). 200.1 to 211 MHz in Range 11, 201 to 310 MHz in Range 110. Minimum amplitude is -15 dBm. For normal operating modes connect this VTO output to the LO INPUT (item 3). When using 8601A as a tracking generator leave VTO output unconnected.
- ③ LO INPUT (Option 007 only). For normal operating modes, connect VTO output (item 2) to LO INPUT. When using 8601A as a tracking generator connect output of external oscillator to LO INPUT.
- ④ AUX OUT (Option 004 only). Auxiliary output used for frequency monitoring.

Output level is approximately 0.5V p-p into 200 ohms. Output frequency is 0.1 to 11 MHz on both ranges. (Range 110 output is divided by ten.)

- ⑤ Line Voltage Switch. Slide switch selects proper primary circuit for 115 or 230 Vac operation. Exposed number indicates primary voltage to be used.

CAUTION

Before plugging in power cable, check that line voltage switch is set for correct ac line voltage.

- ⑥ Power cable connector.
- ⑦ LINE FUSE. Primary circuit overcurrent protection. For 115 Vac operation, use 1

Figure 3-2. Rear Panel Controls and Connectors (1 of 2)

REAR PANEL FEATURES

- amp, slow-blow fuse. For 230 Vac operation, use 0.5 amp, slow-blow fuse.
- ⑧ UNCAL RF. RF output concurrent with front panel RF OUT but is not calibrated or blanked during sweep retrace.
 - ⑨ BLANKING. Output is a rectangular pulse of approximately $-4V$ that occurs during retrace portion of sweep.
 - ⑩ VTO OUTPUT. 200.1 to 211 MHz in range 11; 201 to 310 MHz in range 110. Minimum amplitude is -15 dBm.
 - ⑪ SWEEP. Sweep voltage output concurrent with RF sweep. Output is approximately 0 to $+7V$ in all sweep modes.
 - ⑫ SWEEP INHIBIT. A sweep inhibit pulse (momentary ground), adjustable for any frequency point across the swept range, is applied to momentarily stop the 8601A sweep. This pause enables the HP Model 8600A Digital Marker to measure the frequency at that particular point in the sweep.
 - ⑬ Identification Plate. Serial number that identifies individual instrument. First three or four digits identify the serial prefix. If instrument includes a standard modification (called an Option) then the option number is given on the identification plate just below the serial number.

Figure 3-2. Rear Panel Controls and Connectors (2 of 2)

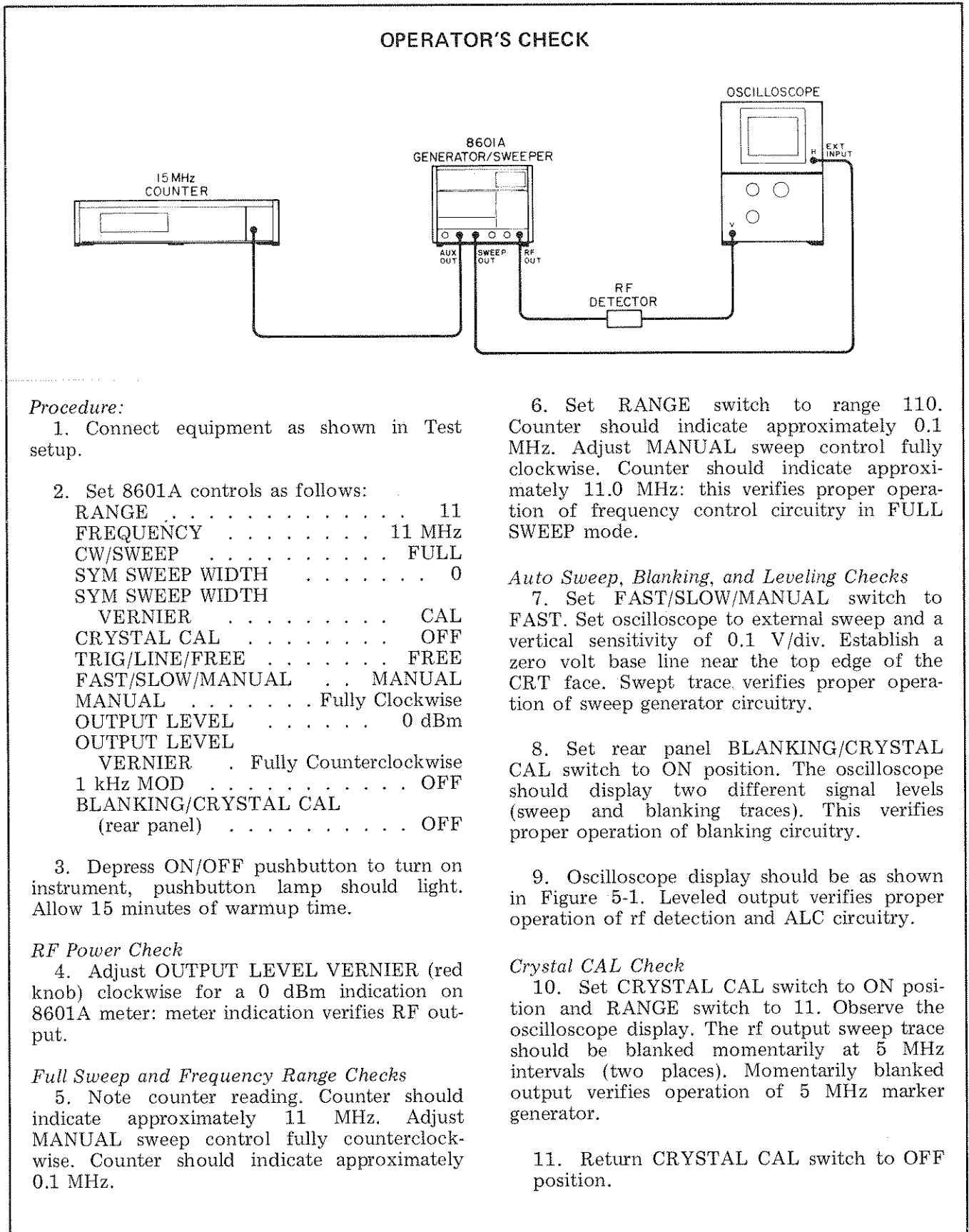

Figure 3-3. Operator's Check (1 of 2)

OPERATOR'S CHECK*Video Sweep Check*

12. Set CW/SWEEP control to VIDEO and adjust FREQUENCY control for 5 MHz.

13. Set FAST/SLOW/MANUAL switch to MANUAL and adjust MANUAL control fully clockwise.

14. Counter should indicate approximately 5 MHz (upper frequency limit of VIDEO SWEEP).

15. Adjust MANUAL control fully counterclockwise. Counter should indicate approximately 0.1 MHz (lower frequency limit of VIDEO SWEEP). Frequency outputs verify proper operation of frequency control circuitry in VIDEO SWEEP mode.

SYM Sweep Check

16. Set CW/SWEEP switch to SYM. Adjust FREQUENCY control for a counter indication of 5.0 ± 0.1 MHz.

17. Set SYM SWEEP WIDTH control to 1 MHz (blue numbers).

18. Adjust MANUAL control from fully counterclockwise position to fully clockwise position. Counter should indicate a total frequency change of approximately 1 MHz. This verifies proper operation of frequency control circuitry in SYM SWEEP mode.

Modulation Check

19. Set 1 kHz MOD switch to AM position and set oscilloscope for an internal sweep of 1 ms/div. Oscilloscope display should appear as a 1 kHz sine wave. This verifies proper operation of internal 1 kHz oscillator circuitry.

This completes the operator's check. Detailed performance testing procedures are given in Section IV.

Figure 3-3. Operator's Check (2 of 2)

FRONT PANEL OPERATION

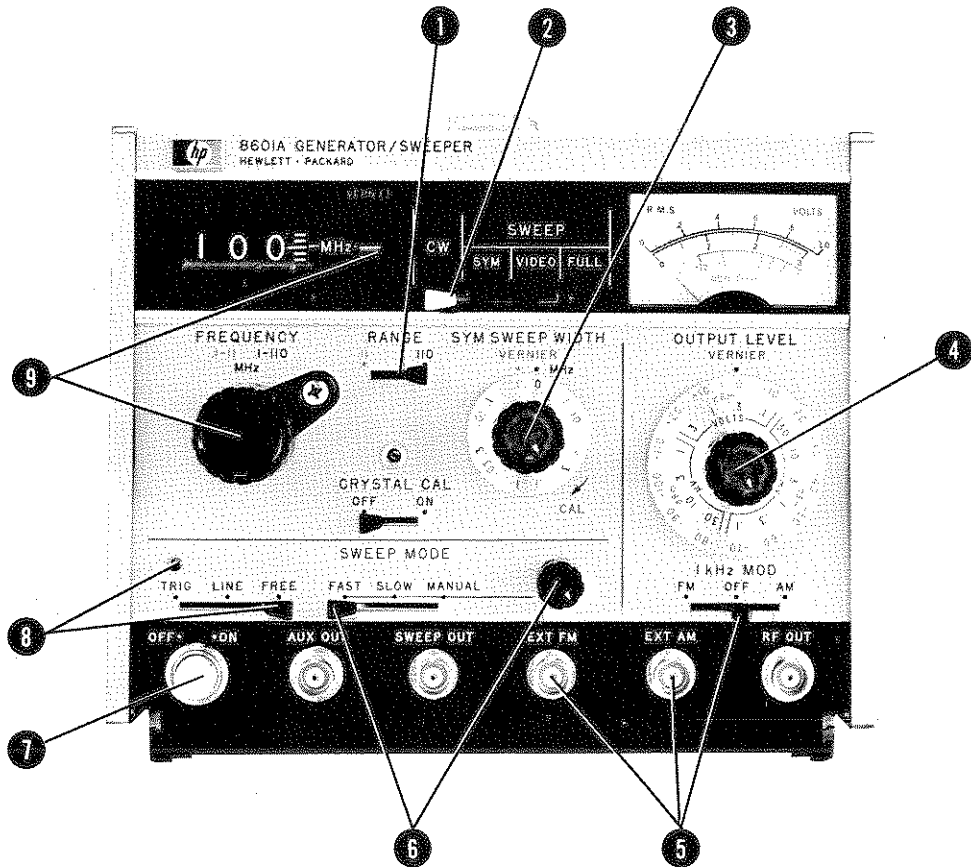

1 Select the frequency range desired:

Range 11: 0.1 to 11 MHz
 Range 110: 1.0 to 110 MHz

2 Select mode of operation desired:

FULL: Sweeps full band 0.1 to 11 MHz on range 11; 1 to 110 MHz on range 110.

VIDEO: Sweeps from bottom of band (0.1 or 1.0 MHz) up to frequency indicated on digital frequency readout.

SYM: Sweeps upward, centered on CW frequency indicated on digital frequency readout.

CW: RF output frequency is indicated on digital frequency readout.

3 If using the SYM sweep operation, select the desired sweep width. Sweep width is calibrated when VERNIER is in CAL position. VERNIER can be used to vary sweep width from calibrated width to zero. Blue numbers on dial correspond to range 11, black numbers correspond to range 110.

4 Adjust for the desired output level. Calibrate output by adjusting for 0 dBm reading with OUTPUT LEVEL VERNIER.

5 Apply frequency or amplitude modulation as desired.

Figure 3-4. Front Panel Operation (1 of 2)

FRONT PANEL OPERATION

NOTE

Internal modulation is obtained with 1 kHz MOD switch set to AM or FM. External modulation is obtained with MOD switch to OFF and external signal applied to EXT AM or EXT FM jack.

Internal am, fm or external am may be applied in CW or any sweep mode. External am limits are shown in Figure 3-9.

External fm may be applied in any sweep mode, except CW mode. External fm limits are shown in Figure 3-8.

- 6 Select the desired sweep speed or manual operation. In FAST and SLOW position, the manual control serves as a sweep speed vernier. Clockwise rotation increases sweep speed.

FAST: 3 to 60 sweeps/second
SLOW: 3 to 60 seconds/sweep

- 7 Depress ON/OFF button. Allow two hour warmup.

- 8 Select the desired sweep trigger:

TRIG: Sweep is started by depressing trigger button. Retrace occurs automatically or sweep may be terminated manually by depressing trigger button a second time.

LINE: Sweep is synchronized with line frequency.

FREE: Sweep free runs.

- 9 Tune to the desired frequency on the digital frequency readout. The VERNIER can be used to fine-tune the frequency approximately $\pm 0.1\%$ of frequency

Figure 3-4. Front Panel Operation (2 of 2)

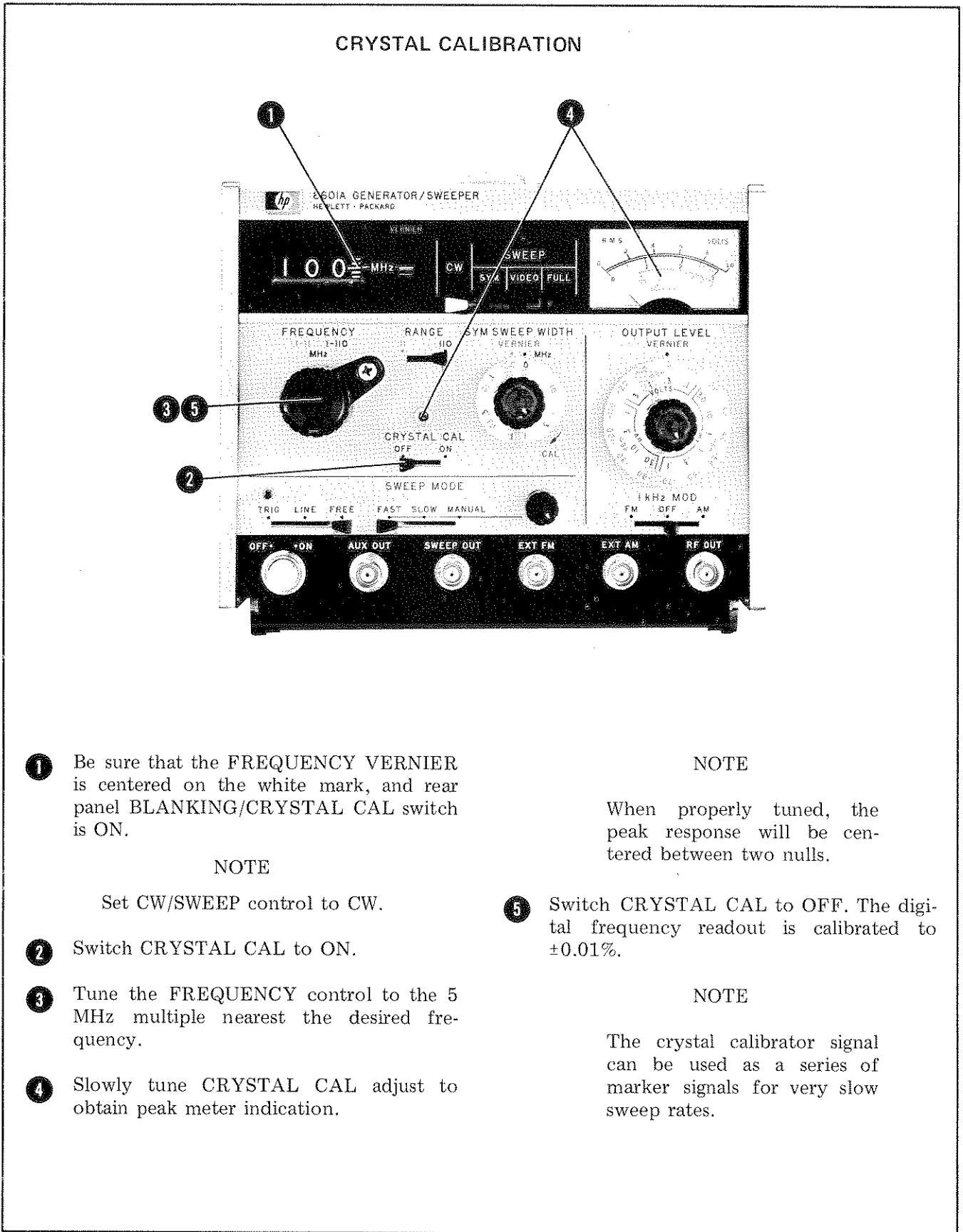

- 1 Be sure that the FREQUENCY VERNIER is centered on the white mark, and rear panel BLANKING/CRYSTAL CAL switch is ON.

NOTE

Set CW/SWEEP control to CW.

- 2 Switch CRYSTAL CAL to ON.
- 3 Tune the FREQUENCY control to the 5 MHz multiple nearest the desired frequency.
- 4 Slowly tune CRYSTAL CAL adjust to obtain peak meter indication.

NOTE

When properly tuned, the peak response will be centered between two nulls.

- 5 Switch CRYSTAL CAL to OFF. The digital frequency readout is calibrated to $\pm 0.01\%$.

NOTE

The crystal calibrator signal can be used as a series of marker signals for very slow sweep rates.

Figure 3-5. Crystal Calibration

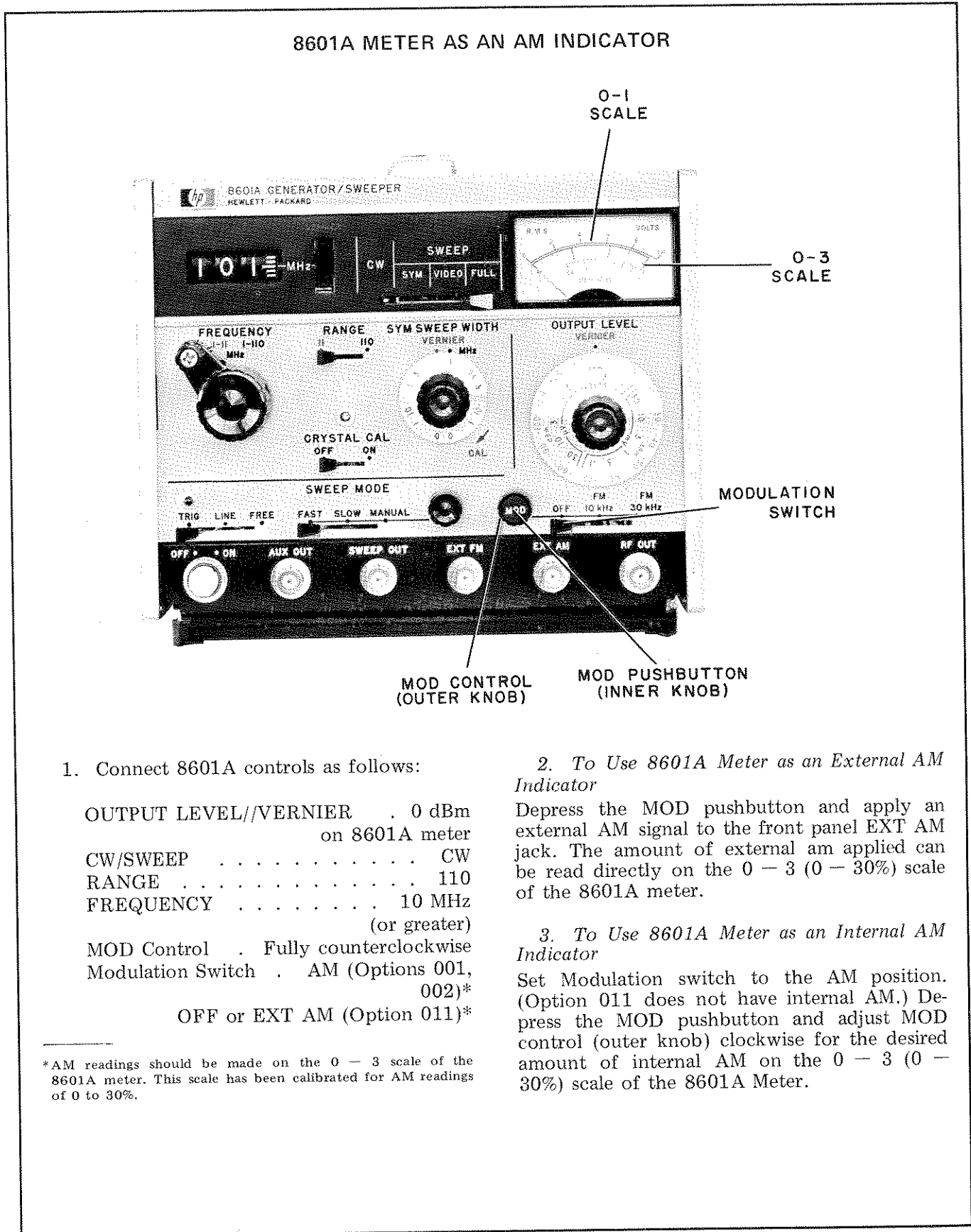

Figure 3-6. Using 8601A as AM Indicator (Options 001, 002, 011)

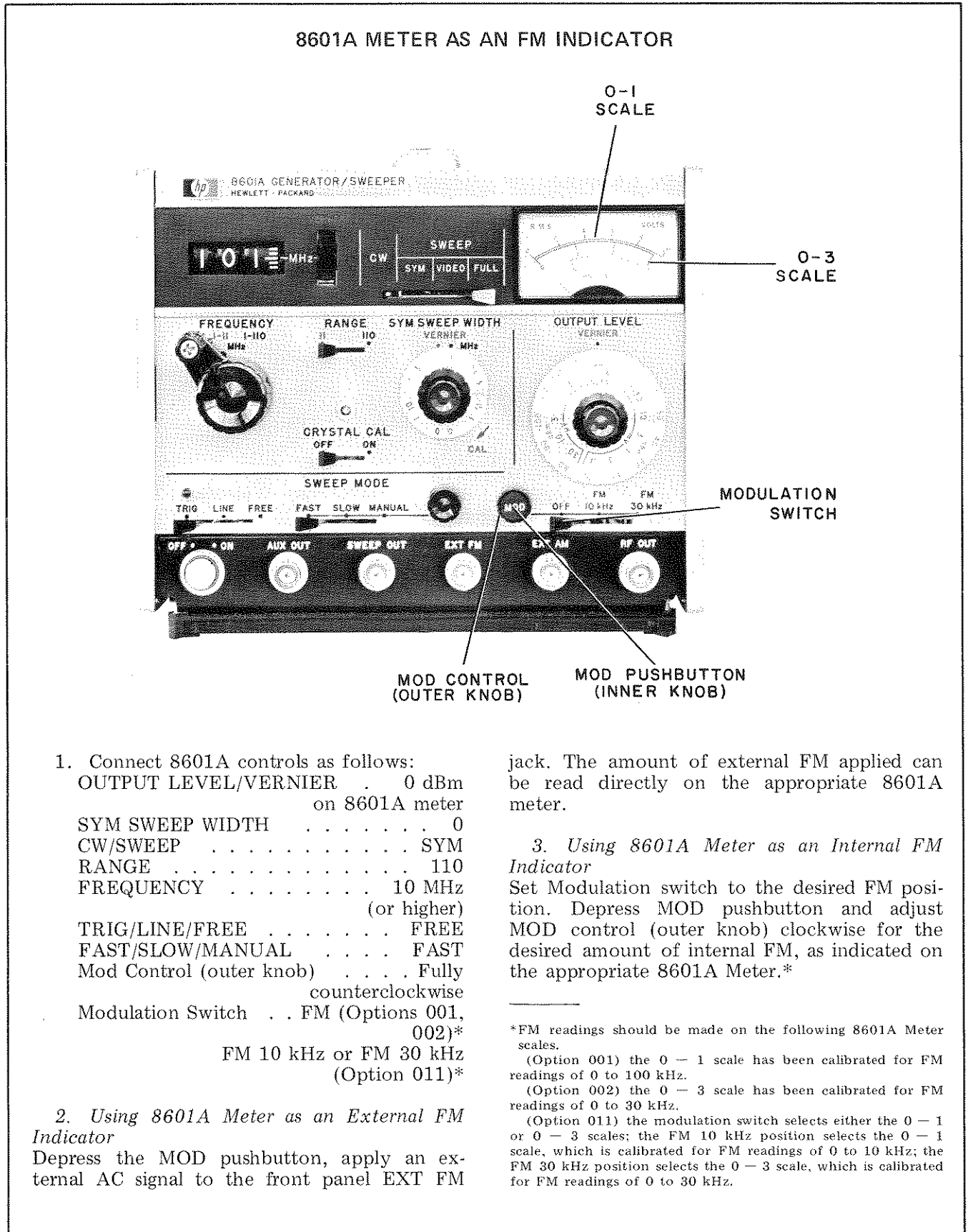

Figure 3-7. Using 8601A Meter as an FM Indicator (Options 001, 002, 011)

±5% at a 1 kHz rate. The external am is adjustable from about 10% at 0.5 kHz rate, 50% at a 400 Hz rate, 80% at a 10 Hz rate (see Figure 3-9 for maximum limits).

3-19. For AM operation, the rf output level should be adjusted before applying modulation. The meter monitors the output of a peak detector and, therefore, reads a greater apparent rf level when amplitude modulation is applied.

3-20. OPERATOR'S MAINTENANCE

3-21. Fuses

3-22. Fuse F1, located on the rear panel, is installed in the primary circuit of power transformer T1, to protect the instrument. For 115 Vac operation, F1 should be a standard 1 amp, slow-blow fuse, for 230 Vac operation, F1 should

be a standard 0.5 amp, slow-blow fuse. Refer to parts list in Section VI for fuse part number.

3-23. Fuses A8F1 and A8F2 are located on rectifier board A8. A8F1 is a standard 2 amp, slow-blow fuse, that protects the +20V and -6.3V power supplies. A8F2 is a standard 0.125 amp, slow-blow fuse, that protects the -75V power supply. Refer to parts list in Section VI for fuse part number.

3-24. Lamp Replacement

3-25. The front panel indicator lamp located in the ON/OFF switch is replaceable from the front. Pull the white pushbutton straight out, and replace the lamp (HP Part Number 2140-0244). Align the pushbutton guide (small protrusion) with the notch in the ON/OFF switch-receptacle and reinsert pushbutton.

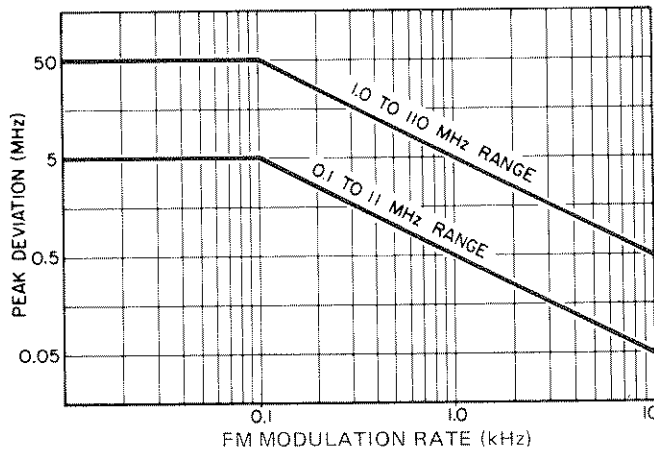

Figure 3-8. Maximum Peak Deviation versus Frequency Modulation Rate

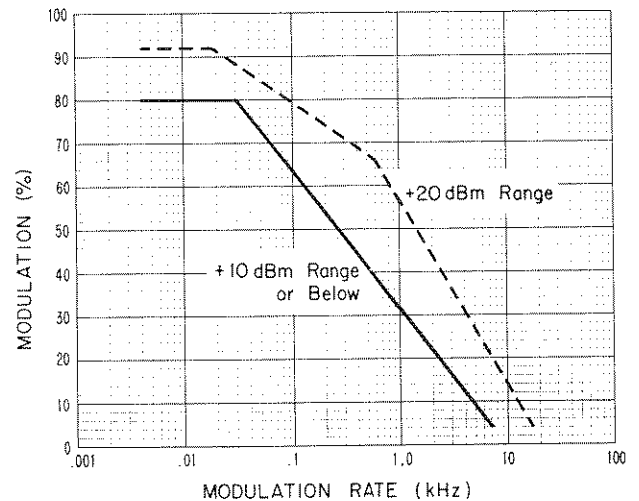
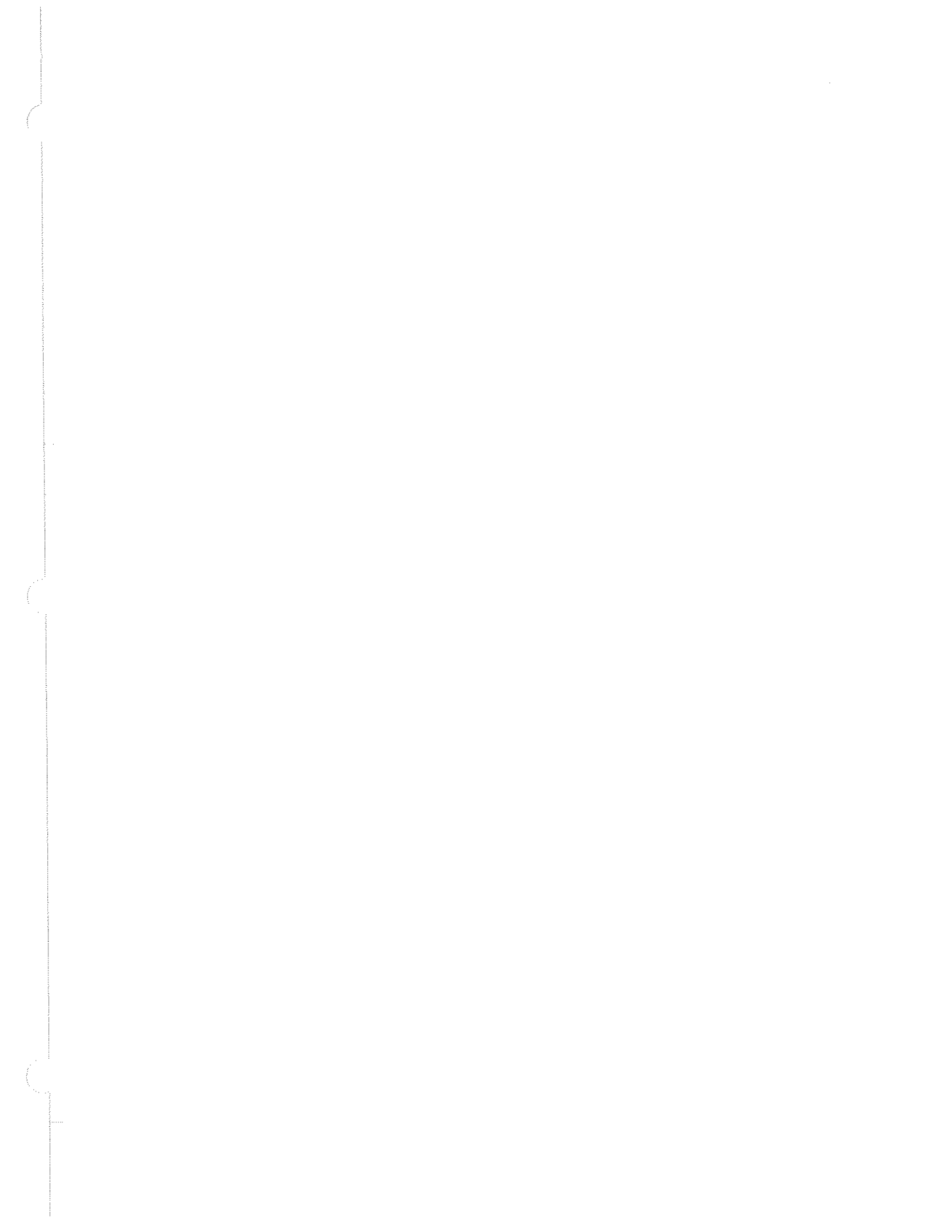

Figure 3-9. Maximum Percent Modulation versus Modulation Rate



SECTION IV PERFORMANCE TESTS

4-1. INTRODUCTION

4-2. The procedures in this section test the instrument's electrical performance (standard instrument and instrument Options 001 - 011) using the specifications of Table 1-1 as the performance standards. All tests can be performed without access to the interior of the instrument. A simpler operational test is included in Section III under Operator's Checks.

4-3. EQUIPMENT REQUIRED

4-4. Equipment required for the performance tests is listed in Table 1-2, Recommended Test

Equipment. Any equipment that satisfies the critical specifications given in the table may be substituted for the recommended models.

4-5. TEST RECORD

4-6. Results of the performance tests may be tabulated on the Performance Test Record (Table 4-2) at the end of the procedures. The Test Record lists all of the tested specifications and their acceptable limits. Test results recorded at incoming inspection can be used for comparison in periodic maintenance and troubleshooting and after repairs or adjustments.

PERFORMANCE TESTS

4-7. Initial Setup. Before proceeding with performance tests, allow the Model 8601A at least a one hour warmup.

4-8. Frequency Coverage/Accuracy

Specification:

Coverage: Low range, 0.1 — 11 MHz; high range, 1 — 110 MHz.

Accuracy (in CW, stop frequency of VIDEO sweep, and center frequency of SYMMETRICAL sweep):

Low Range, $\pm 1\%$ of frequency ± 10 kHz

High Range, $\pm 1\%$ of frequency ± 100 kHz.

Description:

The frequency coverage (range) and accuracy is tested using a counter to measure the model 8601A AUX OUT frequency. The AUX OUT frequency is equal to the actual RF output frequency in low range of the 8601A and is equal to the actual RF output frequency divided by ten (through a precision-internal divider) in the high range of the 8601A.

Equipment:

Counter/Marker Generator HP 8600A

Procedure:

1. Connect counter to 8601A AUX OUT connector.

2. Make the following 8601A settings:

FREQUENCY	0.1 MHz	CRYSTAL CAL	OFF
RANGE	11	SWEEP MODE	FAST
FREQUENCY VERNIER	Centered	TRIG/LINE/FREE	FREE
CW/SWEEP	CW	OUTPUT LEVEL	0 dBm
SYM SWEEP WIDTH	0	OUTPUT LEVEL VERNIER	0 dBm
SYM SWEEP WIDTH VERNIER	CAL		on output meter
		1 kHz MOD	OFF (or EXT)

3. Counter should indicate 0.1 MHz ± 11 kHz.

4. Adjust 8601A FREQUENCY control to 5 MHz.

5. Counter should indicate 5 MHz ± 60 kHz.

6. Adjust FREQUENCY control to 11 MHz.

7. Counter should indicate 11 MHz ± 120 kHz.

8. Set 8601A RANGE switch to 110.

9. Adjust FREQUENCY control to 1 MHz.

NOTE

With RANGE in 110 frequency measured at 8601A AUX OUT jack will be one-tenth the actual frequency output.

10. Counter reading should be 0.1 MHz ± 11 kHz.

PERFORMANCE TESTS

4-8. Frequency Coverage/Accuracy (Cont)**NOTE**

When using a HP Model 8600A counter, the decimal point is automatically shifted one place when 8601A is used on high 110 RANGE. Therefore, for step 10 a HP Model 8600A counter reading should be 1 MHz \pm 110 kHz.

11. Adjust FREQUENCY control to 50 MHz: the counter reading should be 5 MHz \pm 60 kHz.
 12. Adjust FREQUENCY control to 110 MHz: the counter reading should be 11 MHz \pm 120 kHz.
-

4-9. Sweep Characteristics*Specifications:*

Full Sweep: Approximately 0.1 – 11 MHz and 1 – 110 MHz independent of dial setting.

Video Sweep: Sweep extends from low end of range to frequency dial setting. Start frequency accuracy is \pm 1% of stop frequency, \pm 100 kHz, high range; \pm 1% of stop frequency, \pm 10 kHz low range.

Symmetrical Sweep: Center frequency may be tuned to any point on either range:

Sweep Width: 0 – 1 MHz low range; 0 – 10 MHz high range. There are five calibrated sweep width positions as well as an uncalibrated vernier to provide continuous adjustment.

Sweep Width Accuracy: \pm 2% of sweep width or \pm 1 kHz on low range; \pm 2% of sweep width or \pm 10 kHz on high range.

Description:

The sweep characteristics of the 8601A are tested by actually measuring RF frequency points during swept operation with a special electronic counter (the HP Model 8600A). If this special counter is not available, an alternate test of 8601A sweep characteristics can be made with the 8601A in MANUAL SWEEP mode and using a standard electronic counter.

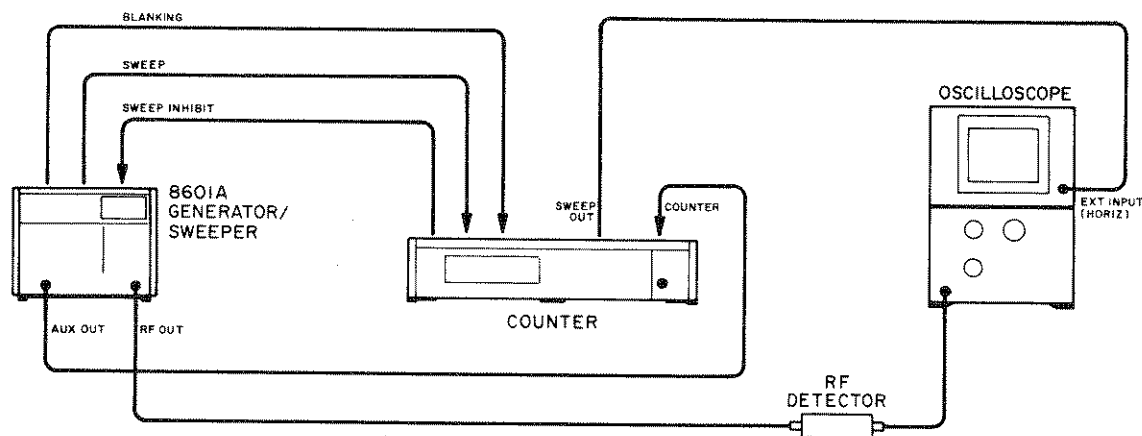

Figure 4-1. Sweep Characteristics Test Setup

PERFORMANCE TESTS

4-9. Sweep Characteristics (Cont)*Equipment:*

RF Detector	HP 8471A
Oscilloscope	HP 180A/1803A/1820A
Counter/Marker Generator	HP 8600A

Procedure:

1. Connect equipment as shown in Figure 4-1.

2. Make the following initial settings:

8601A

RANGE	110	OUTPUT LEVEL	0 dBm
CW/SWEEP	FULL	SYM SWEEP WIDTH	0
SWEEP MODE	FAST/FREE	SYM SWEEP WIDTH VERNIER	CAL
MANUAL SWEEP CONTROL	Fully clockwise	CRYSTAL CAL	OFF
		MOD	OFF (or EXT)

3. Set Counter/Marker Generator for SCOPE/SWEEP mode and Oscilloscope DC coupled-external horizontal input sensitivity for full screen (horizontal line) CRT display.

4. Select a marker to be counted by pushing the pushbutton in the center of the desired marker knob.

NOTE

The marker selected provides a brighter marker dot than the other dots.

5. Position selected marker to highest swept frequency point on display. The counter indication should be 110 to 120 MHz.

6. Push a different pushbutton and position newly selected marker to lowest swept frequency point on display. The counter indication should be 0.98 to 3 MHz.

7. Set 8601A range to 11 and reposition selected markers, if necessary measure highest and lowest swept frequencies. Highest frequency should be 11 to 12 MHz. Lowest frequency should be 0.1 to 0.3 MHz.

8. Set 8601A CW/SWEEP control to VIDEO and FREQUENCY control to 10 MHz.

9. Select and position markers on highest and lowest frequency point on display. The lowest frequency should be 0.1 ± 0.11 MHz. The highest frequency should be 10 ± 0.11 MHz.

NOTE

Frequency of the 8601A AUX OUT jack when in RANGE 110 will be one-tenth the actual frequency output.

10. Set 8601A to range 110 and FREQUENCY control to 100 MHz.

11. Select and position markers on highest and lowest frequency point on display. The lowest frequency should be 1 ± 1.1 MHz. The highest frequency should be 100 ± 1.1 MHz.

12. Set 8601A CW/SWEEP control to SYM, SYM SWEEP WIDTH control to 10 MHz, SYM SWEEP WIDTH VERNIER to CAL, and SWEEP MODE to FAST/FREE.

PERFORMANCE TESTS

4-9. Sweep Characteristics (Cont)

- 13. Position a selected marker to center of oscilloscope swept display line.
- 14. Adjust 8601A FREQUENCY control for counter indication of 100 MHz.
- 15. Position a selected marker to highest frequency point on display. Note counter indication. Position a selected marker to lowest frequency point on display. Note this counter indication.
- 16. The difference between the two counter indications should be within the test limits in the table below. Set the RANGE and SYM SWEEP WIDTH controls to each of the positions in the table below. Repeat step 15 for each setting and compare to the corresponding test limits.

Table 4-1. SYM SWEEP WIDTH Accuracy Test

RANGE	Calibrated SYM SWEEP WIDTH	Highest, Lowest Difference Frequency Test Limits	
		Minimum	Maximum
110	10	9.8 MHz	10.2 MHz
110	3	2.94 MHz	3.06 MHz
110	1	0.98 MHz	1.02 MHz
110	.3	0.29 MHz	0.31 MHz
110	.1	.09 MHz	0.11 MHz
11	1	980 kHz	1020 kHz
11	.3	294 kHz	306 kHz
11	.1	98 kHz	102 kHz
11	.03	29 kHz	31 kHz
11	.01	9 kHz	11 kHz

NOTE

Steps 17 through 20 comprise an alternate method for testing the symmetrical sweep using a standard electronic counter.

- 17. Connect electronic counter to 8601A RF OUT connector.
- 18. Set 8601A controls as follows:
 RANGE.....110
 FREQUENCY..... 45 MHz
 SWEEPSYM
 SYM SWEEP WIDTH 10 MHz
 SYM SWEEP WIDTH VERNIER..... CAL
 SWEEP MODEMANUAL
- 19. Set SWEEP MODE MANUAL control full clockwise note frequency on counter. Set SWEEP MODE MANUAL control full counter-clockwise and note this frequency.
- 20. The difference between the two counter indications should be within the test limits in the table above. Set the RANGE and SYM SWEEP WIDTH controls to each of the positions in the table above. Repeat step 19 for each setting and compare to the corresponding test limits.

PERFORMANCE TESTS

4-10. Linearity

Specification:

Linearity: $\pm 0.5\%$ of full sweep.

Description:

Linearity (RF output frequency versus sweep output voltage) can be checked two ways. Measuring RF frequency points during swept operation with an oscilloscope and a special electronic counter (HP Model 8600A) or calibrating an X-Y recorder and plotting the 5 MHz markers of the internal 8601A Crystal Calibrator. Both measurement techniques are described in the following procedure.

NOTE

The accuracy of the special counter technique is dependent on the oscilloscope accuracy.

Procedure:

Special Counter Technique

1. Use equipment setup of Figure 4-1.
2. Make the following initial settings:

CW/SWEEP	FULL	OUTPUT LEVEL	0 dBm
SWEEP MODE	FAST/FREE	CRYSTAL CAL	OFF
MANUAL SWEEP		MOD	OFF (or EXT)
CONTROL	Full clockwise	RANGE	110
3. Set Counter/Marker Generator for SCOPE/SWEEP and de-couple the oscilloscope for external horizontal sweep. Adjust the oscilloscope horizontal control, input sensitivity for full screen (horizontal line) display.
4. Select a marker to be counted by pushing the pushbutton in the center of the desired marker knob.
5. Position selected marker to highest swept frequency point on display and record counter reading.
6. Position selected marker to lowest swept frequency point on display and record counter reading.
7. Position selected marker to center of swept display. The counter reading should equal a frequency half way between the highest and lowest swept frequency points.

PERFORMANCE TESTS

4-10. Linearity (Cont)

8. Position selected marker to a point on the swept display that is half way between the lowest and center points. Counter reading should equal a frequency one-quarter way between the highest frequency and lowest frequency.

9. Position selected marker to a point on the swept display half-way between the center and highest points. Counter reading should equal a frequency three-quarters of the way between the highest frequency and lowest frequency.

10. Repeat above procedure at all frequency points of interest.

X-Y Recorder Technique

11. Connect equipment as shown in Figure 4-2.

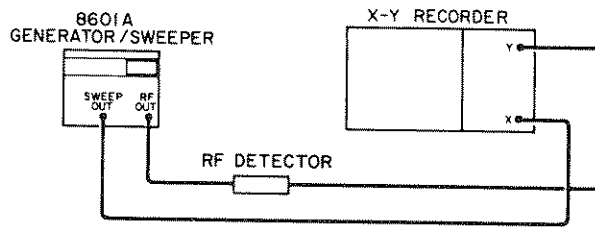

Figure 4-2. Alternate Linearity Test Setup

12. Set 8601A controls as follows:

CW/SWEEP	VIDEO	SWEEP MODE	TRIG/SLOW
RANGE	110	CRYSTAL CAL	ON
FREQUENCY	110 MHz	OUTPUT LEVEL	0 dBm

13. Adjust recorder X-axis sensitivity for 21 cm horizontal display between 1st and last 5 MHz marker. With this calibration, 1 mm equals 0.5% of sweep width.

14. Depress TRIG button to obtain sweep.

15. Markers are visible every 5 MHz and occur every cm (also occur ≈ 2.5 cm below 10 MHz) ± 1 mm (1 mm = 0.5% linearity).

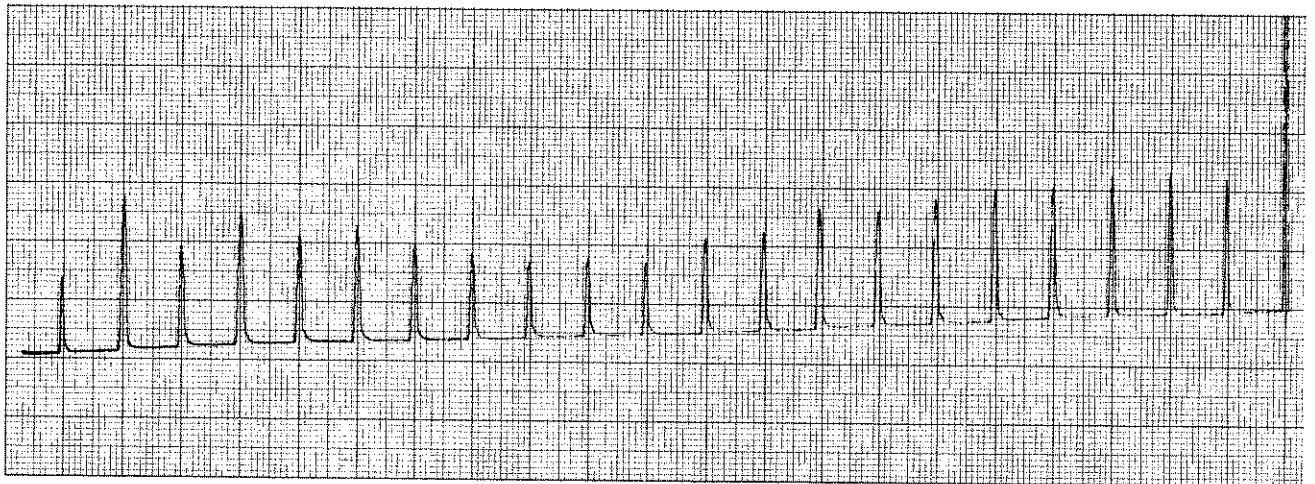

Figure 4-3. Recorder Trace of Linearity

PERFORMANCE TESTS

4-11. Amplitude Modulation

Specification:

Standard Instrument and Options 003, 004 and 006 — 010

Internal AM: 30% ±5% at 1 kHz, less than 3% distortion. Typically <1% distortion for output readings on upper half of meter scale.

External AM: Zero to 50%, up to 400 Hz. Zero to 30%, up to 1 kHz. Applied through external AM input on front panel. Sensitivity typically 2V peak/10% modulation index at 400 Hz (10 — 50% AM).

Option 001 and 002 Instruments

Same as standard instrument, except:

1. Output level meter usable as 0 — 30% AM monitor for internal or external AM with ±3% accuracy for 22 to 30% AM levels (50 Hz to 1 kHz rates).
2. Internal AM adjustable 0 — 30%.

Option 005 Instrument

Same as standard instrument, except Internal AM rate is 400 Hz.

Option 011 Instrument

Same as Option 001 instrument except that internal AM is removed from instrument.

Description:

The amplitude modulation rate and level is measured using an oscilloscope.

Equipment:

Oscilloscope HP 180A/1803A/1820A Audio Oscillator HP 200CD

Procedure:

1. Connect oscilloscope to 8601A RF OUT with 50 ohm termination connected in parallel with RF input at oscilloscope input.

NOTE

For Option 008, 009 and 010 instruments (75 ohm output impedance) use a 75 ohm to 50 ohm minimum loss pad. Refer to Table 1-2.

2. Make following 8601A settings:

CW/SWEEP	CW	FREQUENCY	10 MHz
OUTPUT LEVEL	+10 dBm	MOD	OFF (or EXT AM)
RANGE	11		

3. Adjust oscilloscope vertical sensitivity for a 5 cm display (oscilloscope horizontal sweep time should be about 0.5 millisecond/div).

4. Connect audio oscillator (1000 Hz) to 8601A EXT AM connector.

5. Adjust audio oscillator amplitude output level for 30% amplitude modulation level as indicated on oscilloscope display (1.5 cm peak-to-trough modulation signal as shown in Figure 4-4).

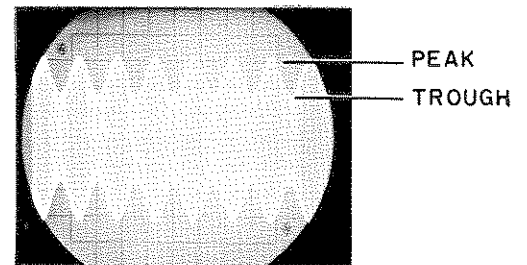

Figure 4-4. Typical Amplitude Modulated Carrier Waveform

PERFORMANCE TESTS

4-11. Amplitude Modulation (Cont)**NOTE**

By varying audio oscillator amplitude output level, the modulation signal should be adjustable from 1.5 cm (peak-to-trough) amplitude to approximately zero amplitude.

AM Monitor TEST (For Option 001, 002 and 011 instruments only)

6. For Option 001 or Option 002 instruments, turn front panel MOD vernier control full counter-clockwise and set AM/FM/OFF switch to AM. For Option 011 instruments, 10 kHz/30 kHz/OFF switch should be set to OFF.

NOTE

For some Option 011 instruments, the OFF position was labeled EXT AM.

7. If necessary, re-adjust audio oscillator for 30% amplitude modulation as in step 5.
8. With front panel MOD pushbutton depressed, the 8601A OUTPUT LEVEL METER should indicate 30 ± 3 divisions ($30 \pm 3\%$) on the 0 — 3 volt scale.

*Internal AM Test***NOTE**

The Option 011 instrument does not have internal AM.

9. Remove 8601A EXT AM input signal.
10. Set OFF/AM/FM switch to AM. For Option 001 and 002 instruments, push MOD button and adjust MOD vernier control for 30% output level meter reading on 0 — 3V scale.
11. Internal amplitude modulation level as indicated on oscilloscope should be 1.5 ± 0.25 cm ($30 \pm 5\%$).

4-12. External FM*Specifications:*

Standard Instrument (and Options 004 — 010)

External FM: Sensitivity; 5 MHz per volt $\pm 5\%$, high range; 0.5 MHz per volt $\pm 5\%$ low range; negative polarity.

Deviations to the band edges are possible for rates from DC to 100 Hz; voltages to frequency linearity are $\pm 0.5\%$, allowing remote frequency programming.

Option 001 Instrument

Same as standard instrument except:

Meter is usable as FM peak deviation monitor for FM deviations of 0 — 100 kHz at RF frequencies above 10 MHz. Meter accuracy is ± 5 kHz for 50 Hz to 10 kHz FM rates; ± 10 kHz for 10 to 20 kHz FM rates.

PERFORMANCE TESTS

4-12. External FM (Cont)

Option 002 Instrument

Same as standard instrument, except:

Meter is usable, as FM peak deviation monitor for FM deviations of 0 – 30 kHz at RF frequencies above 10 MHz. Meter accuracy is ± 1.5 kHz for 50 Hz to 10 kHz rates; ± 3 kHz for 10 to 20 kHz rates.

Option 003 Instrument

Same as standard instrument except:

For narrow frequency control up to 300 kHz (30 kHz on low range): External FM sensitivity is reduced to 100 kHz/volt high range; 10 kHz/volt, low range.

Option 011 Instrument

Same as standard instrument, except:

1. Meter is usable as FM peak deviation monitor for deviation rates of 0 – 30 kHz and 0 – 10 kHz at frequencies above 10 MHz.
2. Meter accuracy for 0 – 30 kHz deviation same as Option 002.
3. Meter accuracy for 0 – 10 kHz deviation, ± 0.6 kHz for 50 Hz to 10 kHz rates; ± 1.0 kHz for 10 kHz to 20 kHz rates.

Description:

The frequency modulated carrier signal from the 8601A is down converted to 1.0 MHz using a signal generator and a frequency mixer. This down-converted frequency retains all frequency modulation characteristics of the original signal. It (1 MHz frequency modulated signal) is demodulated, using a calibrated discriminator, and a rms voltmeter is used to measure the magnitude of the modulation signal.

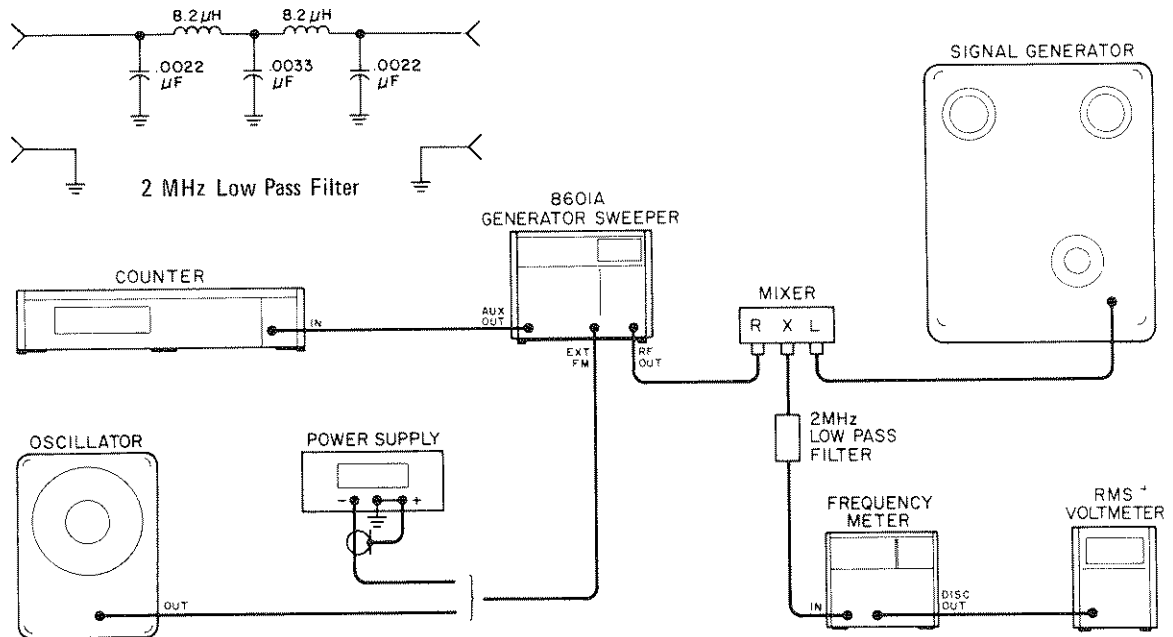

Figure 4-5. External FM Test Setup

Equipment:

Counter/Marker Generator	HP 8600A	Signal Generator	HP 606A and HP 608C
DC Power Supply	HP 6215A	2 MHz Low Pass Filter	(See Table 1-2)
Audio Oscillator	HP 200CD	Digital Voltmeter	HP 3439A/3443A
RMS Voltmeter	HP 3400A		
Frequency Meter	HP 5210A		
Balanced Mixer	HP 10514A or HP 10534A		

PERFORMANCE TESTS

4-12. External FM (Cont)

Procedure (Standard and all Option Instruments)

1. Connect dc power supply to 8601A as shown in Figure 4-5. Connect counter to RF OUT.

NOTE

For Options 008, 009 or 010 instruments 75 ohm output impedance, use a 75 ohm to 50 ohm minimum loss pad. (Refer to Table 1-2).

- | | | | |
|-----------------------------------|--------|---------------------------|---------|
| 2. Set 8601A controls as follows: | | CW/SWEEP | SYM |
| SWEEP MODE | FAST | SYM SWEEP WIDTH | 0 |
| RANGE | 110 | OUTPUT LEVEL | +10 dBm |
| FREQUENCY | 60 MHz | MOD | OFF* |

*For some Option 011 instruments, the OFF position was labeled EXT AM.

3. Increase power supply output in -1 volt steps.

NOTE

For Option 003 instruments, only up to 3 volts.

4. Counter indicates 8601A frequency, increases approximately 5 MHz for every -1 volt step across the band (100 kHz per volt for Option 003 instruments).

5. Set power supply to 0 volt and 8601A RANGE to 11. Connect counter to AUX OUT.

6. Increase power supply in -1 volt steps.

7. Counter indicates 8601A frequency, increases approximately 0.5 MHz for every 1 volt increase across the band (10 kHz per volt for Option 003 instruments).

8. Remove power supply and connect audio oscillator to EXT FM jack.

9. Frequency Meter Calibration. Before connecting the frequency meter in the test setup, calibrate it as follows:

- a. Install shorting board in Model 5210A.

- b. Set sensitivity (volts RMS) to CAL (100 kHz) and range to 100 kHz. The meter should display a full scale indication; if not, adjust screwdriver CAL (100 kHz) as necessary.

- c. Adjust rear panel DISC GAIN CONTROL for -1 volt DC at DISC OUT jack of 5210A (as measured on voltmeter).

- d. Reset SENSITIVITY (volts RMS) to 0.1 Vrms.

- e. Remove internal shorting board and install 10 kHz low pass filter (HP Part No. 10531-6001) in 5210A. The Butterworth configuration is preferred because it provides maximum amplitude response flatness.

NOTE

If internal 10 kHz low pass filter is not available, internal shorting board should be installed in 5210A and 10 kHz low pass filter (see Table 1-2) connected to DISC OUT jack of 5210A.

PERFORMANCE TESTS

4-12. External FM (Cont)

10. Connect equipment as shown in Figure 4-5. Set 8601A RANGE to 110, FREQUENCY to 60 MHz and adjust Signal Generator for 61.0 MHz at a level of about -10 dBm.

11. Set 5210A frequency meter RANGE to 1 MHz, the DISC OUT is now calibrated for 1 MHz/volt (peak). Adjust signal generator frequency for 1 MHz (full scale) frequency meter reading.

12. Set audio oscillator to 1 kHz and adjust output level for 70.7 mV rms voltmeter reading (this indicates a 100 kHz, 8601A frequency peak deviation).

13. Set 8601A FREQUENCY RANGE 11, Control to 10 MHz and repeat steps 11 and 12.

Procedure (Option 001, 002 and 011 Instruments Only)

14. For Option 001 instrument: Set MOD control fully counterclockwise and OFF/AM/FM switch to FM.

15. Push MOD button, the output level meter should indicate 100 ± 5 kHz on 0 — 1 volt scale.

16. For Option 002 and 011 instruments: Set MOD control fully counterclockwise and switch to FM (Option 002) or FM 30 kHz (Option 011). Adjust audio oscillator output level for 21.21 mVrms voltmeter reading (this indicates 30 kHz peak frequency deviation).

17. Push MOD pushbutton, the output level meter should read 30 ± 1.5 kHz on the 0 — 3 volt scale.

18. For Option 011 instruments: With MOD control fully counterclockwise, adjust audio oscillator output level for 7.07 mVrms (indicating 10 kHz peak frequency deviation).

19. Set switch to FM 10 kHz. Push MOD pushbutton, the output level meter should read 10 ± 0.6 kHz on the 0 — 1 volt scale.

4-13. Internal FM

Specifications:

Standard and Option 003, 004, 007 — 010 Instruments:

1 kHz rate; 75 kHz $\pm 5\%$ deviation, high range.

1 kHz rate; 7.5 kHz $\pm 5\%$ deviation, low range.

Option 001 Instruments

1 kHz rate; 0 — 100 kHz peak deviation, high range; 0 — 10 kHz peak deviation, low range.

For RF frequencies >10 MHz an internal deviation monitor provides ± 5 kHz readout accuracy for deviations of 70 to 100 kHz.

Option 002 Instruments

1 kHz rate; 0 — 30 kHz peak deviation, high range; 0 — 3 kHz peak deviation, low range.

For RF frequencies >10 MHz an internal deviation monitor provides ± 1.5 kHz readout accuracy for deviations of 21 to 30 kHz.

Option 005 Instruments

Same as standard instrument, except internal AM rate is 400 Hz.

PERFORMANCE TESTS

4-13. Internal FM (Cont)*Option 006 Instruments*

Same as standard instrument, except internal FM deviation is 22.5 kHz \pm 5% on high range and 2.25 kHz \pm 5% on low range.

Option 011 Instruments

Same as Option 002 instrument, additionally: a 0 – 10 kHz deviation, high range is provided with internal deviation monitor, usable above 10 MHz, accuracy of \pm 0.6 kHz for deviations of 7 to 10 kHz.

NOTE

Internal FM operation is not guaranteed on low range.

Description:

The frequency modulated carrier signal from the 8601A is down converted to 1 MHz (or 100 kHz) using a signal generator and a balanced mixer. This down converter signal retains all frequency modulation characteristics of the original signal. It (1 MHz or 100 kHz signal) is demodulated, using a calibrated discriminator, and an rms voltmeter is used to measure the magnitude of the modulation signal.

Procedure (all instruments):

1. Setup equipment as shown in Figure 4-5. Audio Oscillator, DC Power Supply and Counter/Marker Generator are not needed.

2. Set 8601A controls as follows:

SWEEP MOD	FAST	SYM SWEEP WIDTH	0
RANGE	110 MHz	OUTPUT LEVEL	+10 dBm
FREQUENCY	60 MHz	MOD	FM
CW/SWEEP	SYM		(or FM 30 kHz)

3. Frequency Meter Calibration:

- a. Install shorting board in 5210A.
- b. Set sensitivity (volts RMS) to CAL (100 kHz) and range to 100 kHz. The meter should display a full scale indication; if not, adjust screwdriver CAL (100 kHz) as necessary.
- c. Adjust rear panel DISC GAIN CONTROL for -1 volt DC at DISC OUT jack of 5210A.
- d. Reset sensitivity (volts rms) to 0.1 Vrms.
- e. Remove internal shorting board and install 100 kHz low pass filter (HP 10531-6002) in 5210A (the Butterworth configuration is recommended).

4. Set 5210A frequency meter RANGE to 1 MHz.

5. Adjust signal generator frequency for 1 MHz (full scale) frequency meter reading.

6. RMS voltmeter indication should be:

- a. For Standard and Options 003, 004, 005, 007, 008, 009 and 010 instrument: 53 mVrms \pm 5%.
- b. For Option 006 instrument: 15.9 mVrms \pm 5%.

PERFORMANCE TESTS

4-13. Internal FM (Cont)

c. For Option 011 instruments: Voltmeter indication should be adjustable to 70.7 mVrms using MOD control.

NOTE

With MOD button pushed the 8601A OUTPUT LEVEL meter should indicate 100 ± 5 kHz on the 0 — 1 volt scale (1 = 100 kHz).

d. For Option 002 and 011 instruments: The voltmeter indication should be adjustable to 21.2 mVrms using MOD control.

NOTE

With MOD button pushed the 8601A OUTPUT LEVEL meter should indicate 30 ± 1.5 kHz on the 0 — 3 volt scale (3 = 30 kHz).

e. For Option 011 instruments: Adjust FM 30 kHz switch to FM 10 kHz. Voltmeter indication should be adjustable to 7.07 mVrms and MOD button push should cause 10 ± 0.6 kHz indication on OUTPUT LEVEL meter on 0 — 1 volt scale (1 = 10 kHz).

7. Set 8601A RANGE to 11 (low range).
8. Remove 100 kHz low pass filter from 5210A frequency meter and install 10 kHz low pass filter.
9. Set 5210A frequency meter RANGE to 100 kHz.
10. Adjust signal generator frequency for 100 kHz (full scale frequency meter reading).
11. RMS voltmeter indication should be:
 - a. For Standard and Options 003, 004, 005, 007, 008, 009 and 010 instruments: $53 \text{ mVrms} \pm 5\%$.
 - b. For Option 006 instruments: $15.9 \text{ mVrms} \pm 5\%$.
 - c. For Option 001 instruments: Voltmeter indication should be adjustable to 70.7 mVrms using MOD control.

NOTE

MOD button is not usable on 8601A (0.1 — 11 MHz) low range.

d. For Option 002 and 011 instruments: The voltmeter indication should be adjustable, to 21.2 mVrms using MOD control.

NOTE

MOD button is not usable on 8601A (0.1 — 11 MHz) low range.

PERFORMANCE TESTS

4-14. Residual and Incidental FM

Specifications:

Residual FM (noise in 10 kHz bandwidth including line related components):

CW: <50 Hz rms, low range; <500 Hz rms, high range.

SYM, 0 Sweep: <100 Hz rms, low range; <1000 Hz rms, high range.

Incidental FM (with 30% AM):

SYM, 0 Sweep: <100 Hz peak, low range; <1000 Hz peak, high range.

Description:

Residual FM: The CW signal from the 8601A is down converted to 100 kHz using a signal generator and a frequency mixer. The down-converted frequency retains all frequency stability characteristics of the original CW signal. It (100 kHz signal) is discriminated and used to generate an AC signal proportional to its frequency instability (residual FM) and measured on an rms voltmeter.

Incidental FM: The amplitude modulated CW signal from the 8601A is down converted to 100 kHz and used to generate an AC signal proportional to frequency instability and measured.

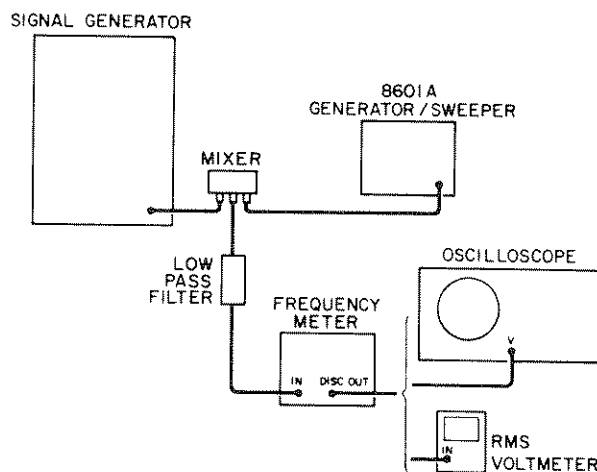

Figure 4-6. Residual and Incidental FM Test Setup

Equipment:

Signal Generator	HP 606A/608A	RMS Voltmeter	HP 3400A
Balanced Mixer	HP 10514A	Oscilloscope	HP 180A/1803A/1820A
	or HP 10534A	2 MHz Low Pass	
Frequency Meter	HP 5210A	Filter	(See Table 1-2)

Procedure:

1. Connect equipment as shown in Figure 4-6.

2. Set 8601A controls:

FREQUENCY	110 MHz	CRYSTAL CAL	OFF
RANGE	110	MODULATION	OFF (or EXT)
CW/SWEEP	CW	OUTPUT LEVEL	+10 dBm

PERFORMANCE TESTS

4-14. Residual and Incidental FM (Cont)*Frequency Meter Calibration*

3. Install internal shorting board into model 5210A.
4. Set sensitivity (volts RMS) to CAL (100 kHz) and range to 100 kHz. The meter should display a full scale indication, if not, adjust screwdriver CAL (100 kHz) as necessary.
5. Adjust rear panel DISC GAIN CONTROL for -1 volt dc at DISC OUT jack of 5210A.
6. Reset SENSITIVITY (volts RMS) to 0.1 Vrms.
7. Set range to 100 kHz. The DISC OUT is now calibrated for 100 kHz/volt or 100 Hz per millivolt.

Residual FM Test

8. Remove internal shorting board and install the 10 kHz low pass filter (HP 10531-6001) in 5210A. The Butterworth configuration is preferred because it provides maximum amplitude response flatness.
9. Adjust signal generator frequency for about -10 dBm output and 100 kHz difference frequency reading on frequency meter (5210A).
10. Connect rms voltmeter to frequency meter (5210A) DISC OUT. The voltage indication should be less than 5 mVrms (500 Hz).
11. Repeat steps 9 and 10 at any other frequencies of interest in high range (1 – 110 MHz).
12. Set 8601A range to 11 and repeat step 9 at all frequencies of interest in low range (0.1 – 11 MHz). RMS voltmeter indication should be less than 0.5 mVrms (50 Hz).
13. Set 8601A CW/SWEEP to SYM and SYM SWEEP WIDTH to 0.
14. Repeat step 9 at all frequency points of interest in low range (0.1 – 11 MHz). RMS voltmeter indication should be 1 mVrms or less (100 Hz).
15. Set 8601A range to 110. Repeat step 9 at all frequency points of interest. RMS voltmeter indication should be 10 mVrms or less (1 kHz).

Incidental FM Test

16. Replace rms voltmeter with oscilloscope. Line synchronize and ac couple oscilloscope.
17. Set 8601A RANGE to 110, CW/SWEEP to SYM and SYM SWEEP WIDTH to 0.
18. Adjust signal generator frequency for 100 kHz difference frequency reading on frequency meter (5210A).
19. Set 8601A 1 kHz MOD to AM.

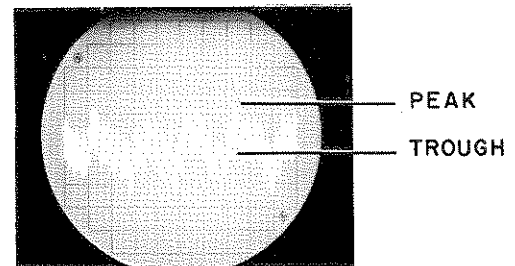

Figure 4-7. Typical Incidental FM Waveform

PERFORMANCE TESTS

4-14. Residual and Incidental FM (Cont)

- 20. Oscilloscope indication should be less than 10 mV peak-to-trough (1 kHz) as shown in Figure 4-7.
- 21. Repeat steps 18 through 20 at all frequencies of interest.
- 22. Set 8601A RANGE to 11.
- 23. Repeat steps 18 and 19 at all frequency points of interest. Oscilloscope indication should be less than 1 mV peak-to-trough (100 Hz).

4-15. Residual AM

Specification:

Residual AM: AM noise modulation index (rms, 10 kHz bandwidth) is < -50 dB.

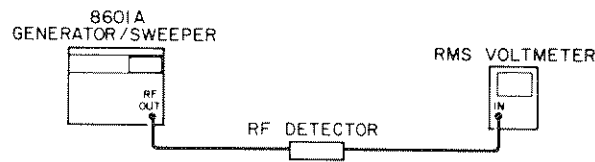

Figure 4-8. Residual AM Test Setup

Equipment:

RF Detector HP 8471A* RMS Voltmeter HP 3400A

*For Options 008, 009 and 010 instruments, use HP 8471A -- Option 005.

Procedure:

- 1. Connect equipment as shown in Figure 4-8.
- 2. Set 8601A controls as follows:

RANGE	11	CW/SWEEP	CW
FREQUENCY	6 MHz	OUTPUT LEVEL	+15 dBm
- 3. Set 8601A 1 kHz MOD to AM.
- 4. Carefully adjust 8601A OUTPUT LEVEL VERNIER to set rms voltmeter at convenient reference point. Record as R1 in dB.
- 5. Set 8601A 1 kHz MOD to OFF.
- 6. Down-range the voltmeter to obtain on scale reading. Record as R2 in dB.

PERFORMANCE TESTS

4-15. Residual AM (Cont)

7. Compute Residual AM: $(R2 - R1) \text{ dB} + (10 \text{ dB})$.
8. Residual AM (step 7 answer) is $>50 \text{ dB}$ below R1 reading.

NOTE

A correction factor of 10 dB is added because the reference R1 set in step 4 is not the actual carrier level. The reference is 10 dB down because of the square-law response of the RF Detector and the response of the Voltmeter to a square wave signal.

4-16. Incidental AM

Specification:

Incidental AM: Modulation index is less than -55 dB with 75 kHz deviation.

Description:

With the carrier signal approximately 30% AM modulated, the actual percent of modulation is measured. This measured modulation signal is then used to establish a reference with respect to the carrier. Since the reference (modulation signal) is not equal to the carrier, a correction factor is determined and added to the measured incidental AM signal (incidental AM is amplitude modulation caused by frequency modulation of carrier signal).

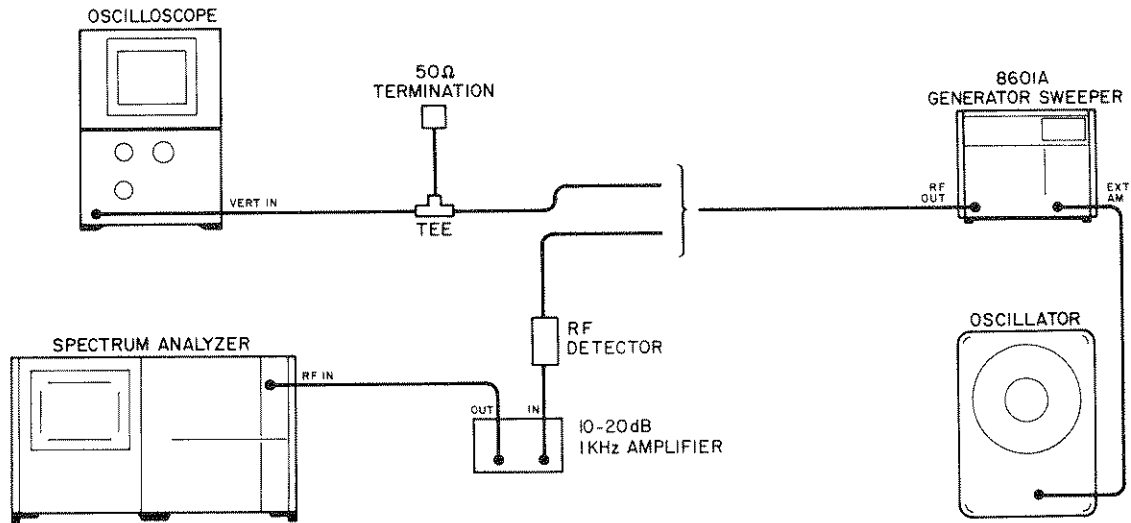

Figure 4-9. Incidental AM Test Setup

Equipment:

RF Detector	HP 8471A	400 MHz Spectrum Analyzer	HP 140T/8552/8553
	(Note 1)	50 Ohm Termination	HP 1250-0207
1 kHz Amplifier	HP 461A or HP 466A	Audio Oscillator	HP 200CD (Note 2)
Oscilloscope	HP 180A/1803A/1820A		

NOTE

1. For Options 008, 009 and 010 instruments, use HP 8471A (Option 005).
2. The Audio Oscillator is only needed for instruments Options 005 and 011.

PERFORMANCE TESTS

4-16. Incidental AM (Cont)

Procedure:

Determining Level of AM Reference Relative to Carrier

1. Connect equipment to oscilloscope as shown in Figure 4-9. Set oscilloscope for internal sweep.

NOTE

1 kHz Audio Oscillator is only needed for 8601A instruments without internal 1 kHz AM (instrument Options 005 and 011).

2. Set 8601A controls:

FREQUENCY	10 MHz	CRYSTAL CAL	OFF
RANGE	110	1 kHz MOD	OFF
CW/SWEEP	CW	OUTPUT LEVEL	0 dBm

NOTE

For instruments without an OFF setting, set 1 kHz MOD switch to AM.

3. Using BNC tee, connect 8601A RF OUT and 50 ohm termination to oscilloscope vertical input.
4. Adjust oscilloscope vertical sensitivity for 5 cm waveform display.
5. Adjust 8601A for 1 kHz AM modulation as follows:
 - a. For all instruments, except instrument Options 001, 002, 005 and 011, set 1 kHz MOD to AM.
 - b. For instrument Options 001 and 002, set MOD switch to AM. With MOD button pushed, adjust MOD control for a three reading on the 0 – 3 volt scale of 8601A OUTPUT LEVEL meter.
 - c. For instrument Options 005 and 011, set MOD switch to OFF (or EXT AM). Connect 1 kHz audio oscillator to EXT AM input and adjust amplitude of audio oscillator for a 1.5 cm peak-to-trough signal on the oscilloscope (30% modulation).

6. Determine the correction factor by difference in amplitude between the 30% amplitude modulation signal level and the unmodulated carrier signal level calculating actual percentage of modulation and referring to the graph in Figure 4-10. To calculate actual percentage divide peak-to-trough amplitude of modulated signal by the peak-to-peak amplitude of the unmodulated signal (5 cm) and multiply by 100.

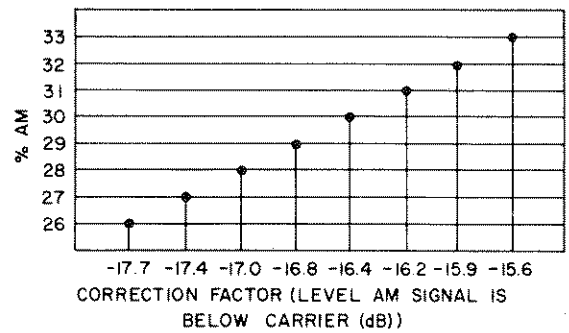

Figure 4-10. Correction Factor Chart

Incidental AM Test

7. Disconnect 8601A RF OUT from oscilloscope and connect to 110 MHz spectrum analyzer as shown.

NOTE

1 kHz amplifier gain should be about 20 dB.

PERFORMANCE TESTS

4-16. Incidental AM (Cont)

8. Set spectrum analyzer controls:

SCAN TIME	0.2 sec.	BANDWIDTH	0.1 kHz
LOG/LINEAR	LOG	CENTER FREQUENCY	0 MHz
INPUT ATTENUATION	20 dB	SCAN WIDTH	1.0 kHz/Div

9. Adjust spectrum analyzer frequency control to center 1 kHz 8601A modulation signal on spectrum analyzer (see Figure 4-11).

NOTE

As shown in Figure 4-11, there are three signals present. Adjust actual 1 kHz signal to center of analyzer display as shown.

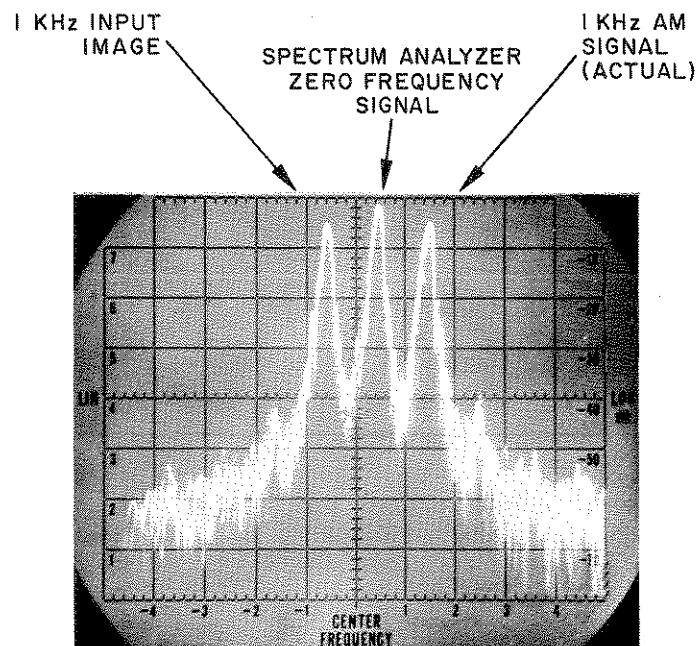

Figure 4-11. Spectrum Analyzer Display

10. Set spectrum analyzer scan width to 0.2 kHz.

11. Adjust spectrum analyzer amplitude controls to display reference signal at top graticule line of spectrum analyzer.

12. Set 8601A 1 kHz MOD control to FM (for instruments being externally modulated, remove modulation signal from EXT AM input and connect to EXT FM input).

PERFORMANCE TESTS

4-16. Incidental AM (Cont)

13. Determine Incidental AM. Incidental AM is equal to the decrease in amplitude of the 1 kHz signal + the correction factor. (Typically the 1 kHz signal level is so small that the actual spectrum analyzer display is only noise.)

NOTE

Example, if the calculated percent of modulation is 30% (step 6) the correction factor will be 16.4 dB (Figure 4-10). Since the minimum level of Incidental AM must be 55 dB below the carrier, the 1 kHz amplitude should decrease by at least 38.6 dB (minimum specification level - correction factor).

4-17. Output Level

Specification:

Level: +20 to -110 dBm into 50 ohms.
Accuracy: ±1 dB for any level from +13 to -110 dBm.

NOTE

For instrument Options 008, 009 and 010, the output level is +18 to -110 dBm into 75 ohms.

Description:

Output level is measured using a spectrum analyzer or RF voltmeter with absolute voltage calibration.

NOTE

Using spectrum analyzer is only approximate check (±0.5 dB).

Procedure Using 110 MHz Spectrum Analyzer:

1. Set 8601A controls as follows:

RANGE 110 MHz OUTPUT LEVEL
FREQUENCY 10 MHz VERNIER Fully counterclock-
CW/SWEEP CW wise
OUTPUT LEVEL +20 dBm CRYSTAL CAL OFF
1 kHz MOD. OFF

2. Connect 20 dB of attenuation (HP 355D) between 8601A RF OUTPUT and the input of the spectrum analyzer. Set spectrum analyzer input attenuation to 20 dB.

NOTE

For Option 008, 009 and 010 instruments (75 ohm output impedance), use a 75 ohm to 50 ohm minimum loss pad. Refer to Table 1-2.

3. Adjust 8601A OUTPUT LEVEL controls for a spectrum analyzer indication of 0 dBm (for 50 ohm output instruments) or a spectrum analyzer indication of -7.7 dBm (for 75 ohm output instruments).

PERFORMANCE TESTS

4-17. Output Level (Cont)

NOTE

The -7.7 dBm level corresponds to +18 dBm attenuated by 25.7 dB in the RF signal path (20 dB attenuator and 5.7 dB attenuation of minimum loss pad).

4. The 8601A output level meter indication should be:
 - a. 0 dBm ±1.5 dB for all 50 ohm output 8601A instruments.
 - b. -2 dBm ±1.5 dB for all 75 ohm output 8601A instruments.

NOTE

Do *Not* change setting of OUTPUT LEVEL vernier control.

5. Reduce the 8601A RF output in 10 dB steps with the coarse OUTPUT LEVEL control. The 8601A meter indication should stay within the tolerances specified in step 4.

4-18. Harmonics and Spurious Signals

Specifications:

All instruments except Options 008, 009 and 010 (CW above 250 kHz, output level below +10 dBm): Harmonics at least 35 dB below carrier. Spurious signals at least 40 dB below carrier.

Instrument Options 008, 009 and 010 (CW above 250 kHz, output level below +10 dBm): Harmonics at least 33 dB below carrier. Spurious signals at least 40 dB below carrier.

Description:

The level of harmonic and spurious signals relative to the carrier signal is measured using a spectrum analyzer with absolute calibration.

Procedure:

1. Connect 8601A RF OUT to input of 400 MHz spectrum analyzer with a 10 dB fixed attenuator connected between 8601A and spectrum analyzer.

NOTE

For Option 008, 009 and 010 instruments (75 ohm output impedance), use a 75 ohm input to 50-ohm output minimum loss pad. Refer to Table 1-2.

2. Set 8601A controls as follows:

RANGE	110	CW/SWEEP	CW
FREQUENCY	1 MHz	OUTPUT LEVEL	+10 dBm

3. Slowly tune the 8601A FREQUENCY from 1 to 110 MHz while observing the spectrum analyzer display for any questionable harmonics or spurious signals.

NOTE

If the input to the spectrum analyzer is overloaded, the spectrum analyzer may originate some mixing harmonics that can appear on the display. If a signal is in question, increase the spectrum analyzer attenuation by 10 dB, note the changes in signal amplitude, then return the attenuator to its original position. If the signal in question originates in the spectrum analyzer, the level will either change by greater or less than 10 dB or it may not change at all.

Table 4-2. Performance Test Record (1 of 3)

Hewlett-Packard Model 8601A Generator Sweeper Serial Number _____		Test Performed by: _____ Date: _____	
	Upper Limit	Measured Value	Lower Limit
4-8. Frequency Coverage/Accuracy			
<i>Range 11</i>			
3. FREQUENCY control to 0.1 MHz	0.111 MHz	_____	0.089 MHz
5. FREQUENCY control to 5 MHz	5.060 MHz	_____	4.940 MHz
7. FREQUENCY control to 11 MHz	11.120 MHz	_____	10.880 MHz
NOTE: Frequency measured at 8601A AUX OUT jack in Range 110 will be one-tenth the actual frequency output.			
<i>Range 110</i>			
10. FREQUENCY control to 1 MHz	0.111 MHz	_____	0.089 MHz
11. FREQUENCY control to 50 MHz	5.060 MHz	_____	4.940 MHz
12. FREQUENCY control to 110 MHz	11.120 MHz	_____	10.880 MHz
4-9. Sweep Characteristics			
<i>Full Sweep (Range 110)</i>			
5. High end frequency	120 MHz	_____	110 MHz
6. Low end frequency	3.0 MHz	_____	0.98 MHz
<i>Full Sweep (Range 11)</i>			
7. a. High end frequency	12 MHz	_____	11 MHz
b. Low end frequency	0.3 MHz	_____	0.1 MHz
<i>Video Sweep (Range 11)</i>			
9. a. Low end frequency	0.21 MHz	_____	0.0 MHz
b. High end frequency	10.11 MHz	_____	9.89 MHz
<i>Video Sweep (Range 110)</i>			
11. a. Low end frequency	2.1 MHz	_____	0.0 MHz
b. High end frequency	101.1 MHz	_____	98.9 MHz
<i>Sym Sweep (Range 110)</i>			
<i>10 MHz Sweep Width</i>			
16.	10.2 MHz	_____	9.8 MHz
<i>3 MHz Sweep Width</i>			
16.	3.06 MHz	_____	2.94 MHz

Table 4-2. Performance Test Record (2 of 3)

	Upper Limit	Measured Value	Lower Limit
4-9. Sweep Characteristics (cont)			
1 MHz Sweep Width 16.	1.02 MHz	_____	0.98 MHz
0.3 MHz Sweep Width 16.	0.31 MHz	_____	0.29 MHz
0.1 MHz Sweep Width 16.	0.11 MHz	_____	0.9 MHz
<i>SYM Sweep (Range 11)</i>			
1 MHz Sweep Width 16.	1020 KHz	_____	980 KHz
0.3 MHz Sweep Width 16.	306 KHz	_____	294 KHz
0.1 MHz Sweep Width 16.	102 KHz	_____	98 KHz
0.03 MHz Sweep Width 16.	31 KHz	_____	298KHz
0.01 MHz Sweep Width 16.	11 KHz	_____	9 KHz
4-10. Linearity			
15. Refer to initial recorder trace of 5MHz markers.			
4-11. Amplitude Modulation			
8. AM Monitor	33%	_____	27%
10. Internal AM	35%	_____	25%
4-12. External FM			
4. External FM (Range 110)		_____	5MHz/V
7. External FM (Range 11)		_____	0.5 MHz/V
12. a. Deviation (Range 110)		_____	70.7 mVrms
b. Deviation (Range 11)		_____	70.7 mVrms

Table 4-2. Performance Test Record (3 of 3)

	Upper Limit	Measured Value	Lower Limit
4-13. Internal FM			
6. Internal FM (Range 110)	55.65 mVrms	_____	50.35 mVrms
11. Internal FM (Range 11)	55.65 mVrms	_____	50.35 mVrms
4-14. Residual and Incidental FM			
<i>CW Mode</i>			
10. Residual FM (Range 110)	5mVrms	_____	
12. Residual FM (Range 11)	0.5 mVrms	_____	
<i>SYM Mode (0 Sweep)</i>			
14. Residual FM (Range 11)	1.0 mVrms	_____	
15. Residual FM (Range 110)	10 mVrms	_____	
20. Incidental FM (Range 110)	10 mV	_____	
23. Incidental FM (Range 11)	1 mV	_____	
4-15. Residual AM			
7. Residual AM		_____	-50 dB
4-16. Incidental AM			
13. Incidental AM		_____	-55 dB
4-17. Output Level			
4. Meter Output Level	+1.5 dB	_____	-1.5 dB
4-18. Harmonics and Spurious Signals			
3. a. Harmonics		_____	-35 dB
b. Spurious Signals		_____	-40 dB



SECTION V ADJUSTMENTS

5-1. INTRODUCTION

5-2. This section provides instructions for adjusting the standard Model 8601A instruments including Options 001 through 011. These procedures should not be performed as routine maintenance, but should be used only after replacement of a part or component, or when the performance test shows that the specifications of Table 1-1 cannot be met.

NOTE

If an instrument includes an Option or Options, the serial plate (rear panel) will list Option number(s).

WARNING

With the covers removed, terminals are exposed that have voltages capable of causing death. The adjustments in this section should be performed only by a skilled person who knows the hazard involved.

NOTE

Before performing any adjustments, allow 1 hour warmup time for the instrument.

5-3. EQUIPMENT REQUIRED

5-4. Recommended test equipment is listed in Table 1-2. If recommended test equipment is not available, other equipment may be substituted if performance meets the critical specifications listed in the table.

5-5. FACTORY SELECTED COMPONENTS

5-6. Table 5-1 is a list of factory selected components by reference designation, reason for selection, and Service Sheet number on which the component is illustrated. Factory selected components are designated by an asterisk (*) on the schematic diagrams in Section VIII of this manual.

Table 5-1. Factory Selected Components

Selected Component	Reason for Selection	Service Sheet
A3A1R2	Selected to produce an output signal of +2 dBm minimum at A3J1 at 118 MHz.	3
A3A1R3	Selected to produce an output signal of +2 dBm minimum at A3J1 at 118 MHz.	3
A3A1R14 ²	Selected to eliminate noise on the swept carrier when the CRYSTAL CAL switch (S2) is ON.	3
A4A1C7 ³	Selected to give optimum flatness when the output level vernier is fully counterclockwise.	4
A4A1R7	Selected to produce an output signal of -2 dBm \pm 2 dB at A4J2.	4
A5A1R12	Selected to obtain sufficient oscillator frequency range.	5
A6A1R6	Selected to control open loop gain of ALC loop.	6
A9R122	Selected to bring A9R120 approximately into the center of its range when adjusted for input offset voltage.	11
A11R7 ¹	Selected to compensate for tolerance variation in A11R6.	12
A14A1C7 (Option 007 only)	Selected to reduce spurious responses \geq 40 dB below carrier with OUTPUT LEVEL set at +10 dBm and VERNIER set for -10 dBm reading.	13
A15R9 (Options 001, 002, 011 only)	Selected for correct monitor accuracy with 20 kHz FM deviation.	14
A15R35 (Options 001, 002, 011 only)	Selected to center AM adjust range (A15R34).	14

¹ A11R7 must be one of three values: 14.3K OHM (HP Part No. 0698-4307), 14.7K OHM (HP Part No. 0698-3156), or 15K OHM (HP Part No. 0757-0446). Typically, if the measured value of A11R6 is less than 48K, A11R7 should be 15K; if value of A11R6 is between 48K and 52K, A11R7 should be 14.7K; if A11R6 is greater than 52K, A11R7 should be 14.3K.

² The value is selected to eliminate noise on the swept carrier when the CRYSTAL CAL switch S2 is ON. Value should be \geq 909 ohms and \leq 1210 ohms. Nominal value is 1100 ohms.

³ The procedure for selection of C7 is to choose the value that gives the minimum power out on the 110 MHz range with the output level vernier fully counterclockwise.

Table 5-2. Controls Listed in Adjustment Sequence (1 of 2)

Reference Designation	Title	Function Adjusted
A10R11	+20V ADJ	Sets +20V Regulator
A5A1R13	High Frequency ADJ	Adjusts VTO high frequency for 318 MHz (RF OUT = 118 MHz or greater).
A5A1R11	Low Frequency ADJ	Adjusts VTO low frequency for 201 MHz (RF out = 1 MHz).
A4A1L5	200 MHz Amplitude Peaking ADJ	Adjusts crystal oscillator 200 MHz OUTPUT for peak amplitude.
A4A3A1L3	0 – 110 MHz Amplitude Peaking ADJ	Adjusts low pass filter 0 – 110 MHz OUTPUT for peak amplitude.
A3A2A1L3	0 – 110 MHz Amplitude Peaking ADJ	Adjusts loop amplifier 0 – 110 MHz OUTPUT for peak amplitude.
A1A1C6	Slope ADJ	Adjusts frequency linearity across band.
A1A1R29	Frequency offset ADJ	Adjusts ramp voltage for 0 Vdc at low frequency end.
A9R136	ALC Balance ADJ	Adjusts flatness of blanking retrace.
A9R160	Frequency ADJ	Adjusts frequency of internal modulation oscillator.
A9R138	FM Deviation ADJ	Adjusts amount of FM deviation about center frequency.
A9R162	% MOD ADJ	Adjusts amplitude modulation for 30%.
A9R131	METER ADJ	Adjusts meter for 0 dB reading.
A9R181	-10 ADJ	Adjusts meter for -10 dB reading.
A9R88	B ADJ	Adjusts temperature balance for wide sweep ranges.
A9R95	A ADJ	Adjusts temperature balance for symmetrical sweep.
A9R20	Dwell Time ADJ	Adjusts for equal delay time at start and end of each sweep.
A9R120	SYM Fc MIN	Minimizes frequency shift at low end of frequency band when switching CW/SWEEP between SYM and CW.
A9R117	SYM Fc MAX	Minimizes frequency shift at middle of frequency band when switching CW/SWEEP between SYM and CW.
A9R24	VIDEO SWP STOP ADJ	Minimizes frequency shift at high end of frequency band when switching CW/SWEEP between CW and VIDEO.

Table 5-2. Controls Listed in Adjustment Sequence (2 of 2)

Reference Designation	Title	Function Adjusted
A9R34	VIDEO START ADJ	Minimizes frequency shift at low end of band when switching CW/SWEEP between CW and VIDEO.
A9R71	Δ SYM ADJ	Adjusts symmetry of sweep about the center frequency.
A9R75	SYM CAL ADJ	Adjusts sweep width of symmetrical sweep.
A15R22	FM 1 ADJ	Adjusts deviation monitor accuracy for Options 001, 002 and 011 instruments.
A15R15	FM 2 ADJ	Same as A15R22.
A15R34	AM ADJ	Adjusts AM % monitor accuracy for Option 001, 002 and 011 instruments.

ADJUSTMENTS

5-7. Power Supply Adjustment

NOTE

The location of all adjustments is shown in Figures 8-40 thru 8-45 of this manual.

Description:

The +20V power supply is adjusted for correct output voltage.

Equipment:

Digital Voltmeter HP 3439A/3443A

Procedure:

1. Connect the digital voltmeter to XA10 pins 7 – 9 (A10TP1).
 2. Adjust +20V ADJUST A10R11 for +20.0 ±0.01 volts.
-

FREQUENCY RANGE ADJUSTMENTS

5-8. Crystal Oscillator Adjustment

Description:

The crystal oscillator output is first adjusted for the correct power level at 200 MHz output. The oscillator mixer is then adjusted for the correct injection voltage to the video amplifier.

Equipment:

400 MHz Spectrum Analyzer HP 140T/8552/8555
 50 Ohm Termination (subminiature) HP 1250-0839
 BNC to Subminiature Adapter HP 1250-0832

Procedure:

1. Disconnect all cable connections to A4.
2. Remove the six screws holding the board down and remove A4.
3. Place a piece of insulating material across the top of the instrument and set A4 on it. Reconnect the –6.3V and +20V wires and the VTO INPUT cable.
4. Connect the 50 ohm termination to the AM INPUT jack on A4.
5. Connect 400 MHz spectrum analyzer to the 200 MHz OUTPUT jack on A4.

NOTE

Adjustment of A4A1L5 can be critical. When not properly tuned, the 200 MHz signal level is very low.

ADJUSTMENTS

5-8. Crystal Oscillator Adjustment (Cont)

6. Adjust 200 MHz amplitude peaking ADJ A4A1L5 for -2 dBm ± 2 dB.

NOTE

It may be necessary to change the value of resistor A4A1R7 to change the 200 MHz signal level (any increase in resistor resistance will decrease signal level).

7. Disconnect 400 MHz spectrum analyzer from the 200 MHz OUTPUT jack and connect it to the 0 — 110 MHz OUTPUT jack on A4. Reconnect the 200 MHz OUTPUT cable. Disconnect the TUNING VOLTAGE cable connection from the A5 VTO assembly.

8. Adjust 0 — 110 MHz amplitude peaking ADJ A4A3A1L3 for maximum output on the spectrum analyzer. (Minimum output level should be at least -30 dBm).

9. Re-install A4 board and restore all A4 and A5 connections.
-

5-9. VTO Adjustment*Description:*

The voltage-tuned oscillator is adjusted to give frequency coverage over the entire range of the instrument.

Equipment:

Counter/Marker Generator	HP 8600A
Subminiature 50 ohm Termination	HP 1250-0839

Procedure:

1. Disconnect TUNING VOLTAGE cable from A5.
2. Set 8601A RANGE to 110 and connect counter to 8601A AUX OUT.
3. Counter indication should be 11.9 ± 0.1 MHz (119 ± 1 MHz when using HP Model 8600A). If necessary, adjust HIGH FREQ ADJ, A5A1R13.

NOTE

Frequency decreases about 5 MHz if VTO assembly is removed from module box.

4. Attach 50 ohm termination to the TUNING VOLTAGE jack on A5 VTO assembly.
 5. Counter indication should be 100 ± 10 kHz (1 ± 0.1 MHz when using HP Model 8600A). If necessary, adjust LOW FREQ ADJUST A5A1R11.
 6. Remove 50 ohm termination from TUNING VOLTAGE jack and restore all A5 connections.
-

ADJUSTMENTS

PEAK OUTPUT POWER ADJUSTMENT

5-10. Loop Amplifier Adjustment

Description:

The loop amplifier mixer is adjusted for maximum output.

Equipment:

110 MHz Spectrum Analyzer HP 140T/8552/8553
 BNC to Subminiature Adapter HP 1250-0832

Procedure:

1. Set controls as follows:

8601A
 SWEEP MODE FREE/SLOW CW/SWEEP FULL
 RANGE 110 FREQUENCY 110 MHz

2. Disconnect all connections to A3.
3. Remove the six screws holding the board down and remove A3.
4. Place a piece of insulating material across the top, set A3 on it, and reconnect all cables and wires except for the 0 – 110 MHz OUTPUT cable.

NOTE

Disconnect TUNING VOLTAGE cable connection from A5 VTO assembly.

5. Connect 110 MHz spectrum analyzer to the 0 – 110 MHz OUTPUT jack on A3.
6. Adjust amplitude peaking ADJ A3A2A1L3 for maximum power on spectrum analyzer. (Minimum output level should be at least +2 dBm).
7. Re-install A3 board and restore all A3 and A5 cable connections.

FREQUENCY ACCURACY ADJUSTMENTS

5-11. Discriminator and DC Amplifier Adjustments

Description:

The discriminator and dc amplifier are adjusted to produce the correct output frequency for a given dial setting.

Equipment:

Counter/Marker Generator HP 8600A

Procedure:

1. Set the 8601A front panel controls as follows:
 CW/SWEEP CW FREQUENCY 110 MHz
 RANGE 110 OUTPUT LEVEL 0 dBm

ADJUSTMENTS

5-11. Discriminator and DC Amplifier Adjustments (Cont)

2. Connect counter to the 8601A AUX OUT jack.
 3. Adjust SLOPE ADJUST A1A1C6 for 11 MHz counter reading ± 0.12 MHz (110 MHz ± 1.2 MHz counter reading on 8600A).
 4. Set 8601A FREQUENCY control to 1.0 MHz.
 5. Adjust FREQUENCY OFFSET ADJUST A1A1R29 for 100 kHz counter reading ± 11 kHz (1 MHz ± 110 kHz counter reading on 8600A).
 6. Set 8601A RANGE switch to 11.
 7. Set FREQUENCY control to 11 MHz.
 8. Re-adjust A1A1C6 (if necessary) for 11 MHz counter reading ± 0.12 MHz.
 9. Set FREQUENCY control to 0.1 MHz.
 10. Re-adjust A1A1R29 (if necessary) for 100 kHz counter reading ± 11 kHz.
 11. Repeat steps 3 through 10 until no further adjustment is required.
-

5-12. ALC Balance Adjustment*Description:*

The ALC loop is adjusted for a swept leveled output across the band.

Equipment:

Oscilloscope HP 180A/1803A/1820A RF Detector HP 8471A

Procedure:

1. Connect 8601A RF OUT to oscilloscope vertical input via rf detector and SWEEP OUT to horizontal input. Set oscilloscope for external horizontal sweep and a vertical sensitivity of 0.2 V/div. Establish a 0 volt base-line at the center of the oscilloscope display.
 2. Set 8601A controls as follows:

CW/SWEEP	FULL	TRIG/LINE/FREE	FREE
FAST/SLOW/MANUAL	FAST	OUTPUT LEVEL	+10 dBm
 3. If necessary, slowly turn OUTPUT LEVEL VERNIER counterclockwise until power output is leveled across the band as shown in Figure 5-1.
-

ADJUSTMENTS

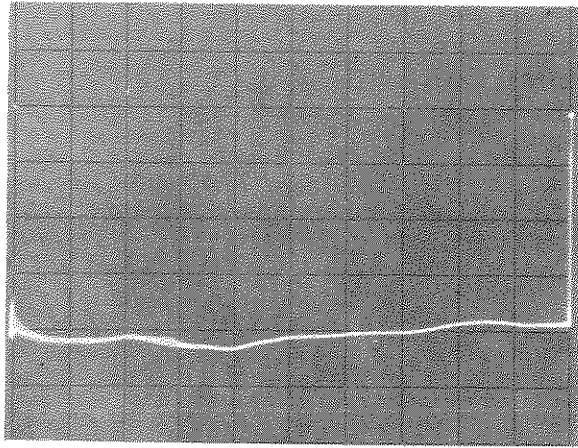

UNLEVELED

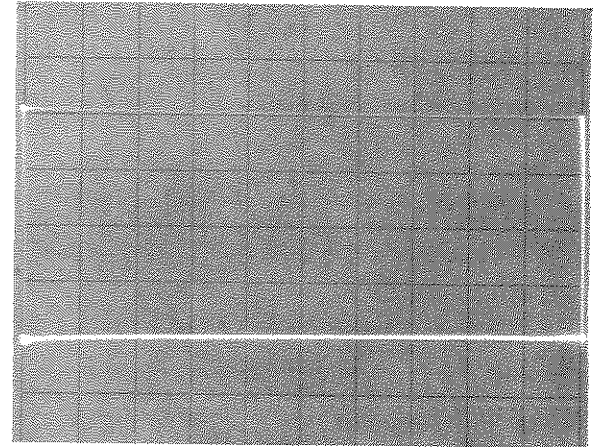

LEVELED

Figure 5-1. Oscilloscope Displays of 8601A RF Output Power

4. Adjust ALC BALANCE ADJUST A9R136 to obtain a flat RF blanking level (top line) across the band as shown in Figure 5-2.

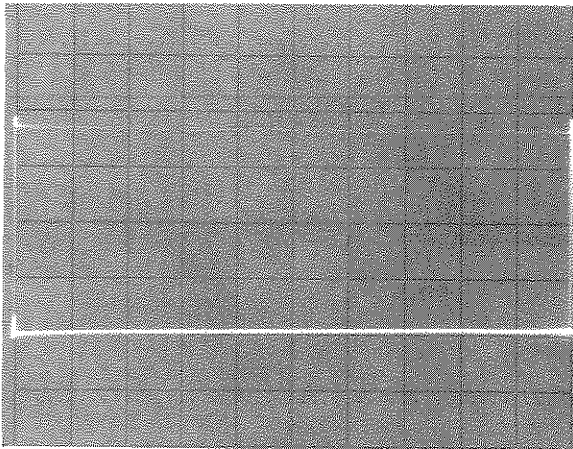

INCORRECT

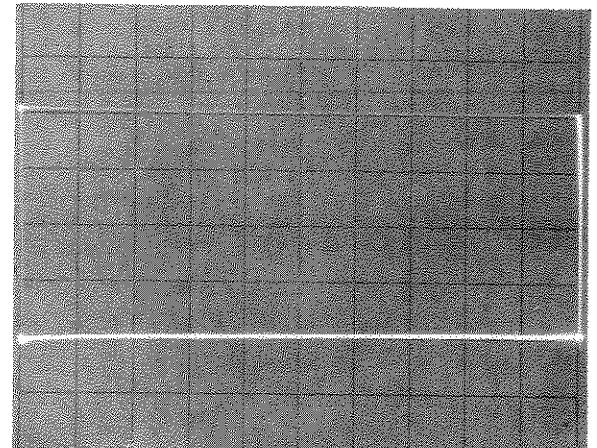

CORRECT

Figure 5-2. Oscilloscope Displays of Correct and Incorrect ALC Balance Adjustment

 ADJUSTMENTS

5-13. Modulation Rate Adjustment
Description:

The modulation is adjusted for a 1 kHz rate (400 Hz for Option 005 instruments).

Equipment:

Counter/Marker Generator HP 8600A

Procedure:

1. Connect counter to A9TP4.
 2. Set 8601A 1 kHz MOD switch to FM.
 3. Adjust FREQ ADJ A9R160 for a 1 kHz counter reading (400 Hz for Option 005 instruments).
-

5-14. FM Adjustment
Description:

The correct FM deviation is adjusted using a calibrated FM discriminator (demodulator) and a monitoring oscilloscope.

Equipment:

Frequency Meter HP 5210A 50 Ohm Termination HP 1250-0207*
 Oscilloscope HP 180A/1803A/1820A BNC Tee Connector HP 1250-0781

NOTE

*75 ohm termination for instrument options 008, 009 and 010.

Procedure:

1. Connect equipment as shown in Figure 5-3.

NOTE

For instrument Options 008, 009 and 010 use 75 ohm termination.

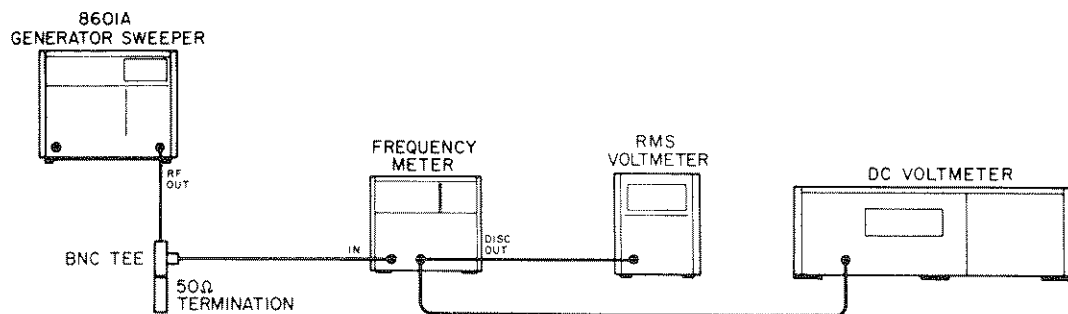

Figure 5-3. Internal FM Adjustment Setup

ADJUSTMENTS

5-14. FM Adjustment (Cont)

2. Calibrate frequency meter as follows:

- a. Install the internal shorting board into the Model 5210A frequency meter.
- b. Set the SENSITIVITY (VOLTS RMS) switch to the CAL (100 kHz) position and the RANGE switch to the 100 kHz position. The meter should display a full scale indication; if not, adjust the screwdriver CAL (100 kHz) control as necessary.
- c. Adjust the rear panel DISC GAIN control for 1 Vdc at the DISC OUT jack.
- d. Reset the SENSITIVITY (VOLTS RMS) switch to 0.1 Vrms.

3. Set controls as follows:

8601A

TRIG/LINE/FREE	FREE	CW/SWEEP	SYM
FAST/SLOW/MANUAL	FAST	1 kHz MOD	FM (or
SYM SWEEP WIDTH	0		FM 30 kHz)
RANGE	110	OUTPUT LEVEL	+10 dBm
FREQUENCY	10 MHz		

NOTE

For option 001, 002 and 011 instruments adjust MOD knob full clockwise.

Frequency Meter

SENSITIVITY (VOLTS RMS)	0.1 Vrms	RANGE	10 MHz
-------------------------	----------	-----------------	--------

Oscilloscope

VERTICAL SENSITIVITY . . .	5 mV/cm	HORIZONTAL TIME/DIVISION . .	0.5 ms/div
----------------------------	---------	------------------------------	------------

4. Install 100 kHz low pass filter (HP 10531A) in the Model 5210A frequency meter in place of the internal shorting board.

NOTE

If 100 kHz low pass filter (HP 10531A) is not available, a 100 kHz low pass filter may be connected to frequency meter output while internal shorting board remains in 5210A.

- 5. Adjust 8601A FREQUENCY control for 10 MHz reading (full scale) on the frequency meter.
- 6. Adjust 8601A FM DEVIATION ADJUST A9R183 for the following rms voltmeter reading:
 - a. For all instruments (except Option 001, 002, 006 and 011 instruments): 5.3 mVrms.
 - b. For Option 001 instruments: 7.1 to 7.7 mVrms.
 - c. For Option 002 and 011 instruments: 2.8 mVrms.
 - d. For Option 006 instruments: 1.59 mVrms.

ADJUSTMENTS

5-14. FM Adjustment (Cont)

Procedure (Option 001, 002 and 011 Instruments Only):

7. Re-adjust 8601A FREQUENCY control, if necessary, for 10 MHz reading (full scale) on the frequency meter.

NOTE

For 8601A instruments Option 011, set modulation switch to FM 10 kHz.

8. Adjust MOD knob for the following rms voltmeter reading:

- a. For Option 001 instruments: 7.07 mVrms.
- b. For Option 002 instruments: 2.12 mVrms.
- c. For Option 011 instruments: 0.707 mVrms.

9. Depress MOD pushbutton and adjust FM1 ADJ (A15R22) and FM 2 ADJ (A15R15) for an 8601A meter reading of:

- a. For Option 001 and 011 instruments: 1 on 0 — 1 volt scale.
 - b. For Option 002 instruments: 3 on 0 — 3 volt scale.
-

5-15. AM Adjustment

Description:

The amplitude modulation percentage is adjusted using a 20 MHz oscilloscope for measurement.

Equipment:

Oscilloscope	HP 180A/1803A/1820A	50 ohm Termination	HP 1250-0207*
BNC Tee Connector	HP 1250-0781	Audio Oscillator	HP 200CD**

NOTE

*For 8601A Options 008, 009 and 010, use 75 ohm termination.

**The Audio Oscillator is required for 8601A Options 001, 002 and 011 only.

Procedure (For all Instruments except Option 011):

1. Connect 8601A RF OUT to oscilloscope vertical input using BNC Tee connector and termination at oscilloscope input.

2. Set controls as follows:

8601A

CW/SWEEP	CW	TRIG/LINE/FREE	FREE
RANGE	11	OUTPUT LEVEL	+10 dBm
FREQUENCY	5 MHz	MODULATION	OFF (or EXT AM)
FAST/SLOW/MANUAL	FAST		

Oscilloscope

VERTICAL SENSITIVITY	0.5 V/cm	HORIZONTAL	
		TIME/DIVISION	0.5 ms/div

ADJUSTMENTS

5-15. AM Adjustment (Cont)

3. Re-adjust oscilloscope vertical sensitivity to obtain a 5 cm display.
4. Set modulation switch to AM.
5. Adjust % MOD ADJUST A9R162 for a peak-to-trough amplitude variation of 1.5 cm (1.5 cm = 30% modulation).

Procedure (Option 001, 002 and 011 Instruments Only):

6. Repeat steps 1 through 3.
 7. Connect 1 kHz audio oscillator to 8601A EXT AM input and adjust oscillator output level for 1.5 cm (30%) peak-to-trough oscilloscope display.
 8. With MOD button depressed, adjust AM ADJ A15R34 for 3.0 (30%) reading on 0 — 3 scale of 8601A meter.
-

5-16. Meter Adjustment

Description:

The meter sensitivity is adjusted so that the reading on the front panel meter corresponds to the actual RF power output.

Equipment:

110 MHz Spectrum Analyzer HP 140T/8552/8553
 75 ohm input to 50 ohm output minimum loss pad (Option
 008, 009 and 010 instruments only)

Procedure:

1. Connect the 110 MHz spectrum analyzer to the 8601A RF OUT jack.

NOTE

For instrument Options 008, 009 and 010, connect 75 to 50 ohm minimum loss pad between 8601A and spectrum analyzer.

2. Set controls as follows:

8601A		RANGE	110
CW/SWEEP	CW	FREQUENCY	60 MHz

Spectrum Analyzer

LOG REF LEVEL	+10 dBm
-------------------------	---------

3. Set 8601A OUTPUT LEVEL to the +10 dBm position and adjust the OUTPUT LEVEL VERNIER for a +10 dBm signal on the spectrum analyzer display.

NOTE

For Option 008, 009 and 010 instruments, spectrum analyzer display should be adjusted for a +10 dBm signal minus attenuation of 75 to 50 ohm minimum loss pad.

ADJUSTMENTS

5-16. Meter Adjustment (Cont)

4. Adjust METER ADJUST A9R131 for +10 dBm (0 dBm on 8601A meter scale).
5. Adjust 8601A OUTPUT LEVEL VERNIER for a 0 dBm signal on the spectrum analyzer display.

NOTE

For Option 008, 009 and 010 instruments, spectrum analyzer display should be adjusted for a 0 dBm signal minus attenuation of 75 to 50 ohm minimum loss pad.

6. Adjust -10 ADJUST A9R181 for 0 dBm (-10 dBm on 8601A meter scale).
 7. Repeat steps 3 through 6 until no further adjustment is required.
-

5-17. Buffer Adjustment*Description:*

The buffers are adjusted for a zero offset of the summing amplifier.

Equipment:

Digital Voltmeter HP 3439A/3443A

Procedure:

1. Disconnect cable from A1J2 FREQ CONTROL jack.
 2. Set 8601A SWEEP switch to SYM.
 3. Ground test points A9TP7 and A9TP10.
 4. Connect the dc digital voltmeter to test point A9TP9.
 5. Adjust SYM Fc MIN A9R120 for 0 volt reading.
 6. Disconnect ground leads from A9TP7 and A9TP10.
 7. Ground test points A9TP8 and A9TP12.
 8. Connect the dc digital voltmeter to test point A9TP7.
 9. Adjust buffer A ADJUST A9R95 for 0 \pm 1 mV reading.
 10. Connect the dc digital voltmeter to test point A9TP10.
 11. Adjust buffer B ADJUST A9R88 for 0 \pm 0.5 mV reading.
 12. Remove grounds from A9TP8 and A9TP12.
 13. Re-connect frequency control cable to A1J2.
-

ADJUSTMENTS

5-18. Dwell Time Adjustment

Description:

The dwell time (horizontal length before and after each ramp), is adjusted for a symmetrical sweep output display.

Equipment:

Oscilloscope HP 180A/1803A/1820A

Procedure:

1. Set controls as follows:

8601A			
CW/SWEEP	FULL	SWEEP MODE	FAST
		TRIG/LINE/FREE	FREE

<i>Oscilloscope</i>			
VERTICAL SENSITIVITY	1 V/cm	HORIZONTAL TIME/DIVISION	5 ms/div

2. Connect oscilloscope to 8601A front panel SWEEP OUT jack.
3. Adjust DWELL TIME ADJUST A9R20 for a symmetrical dwell time on the oscilloscope display.

5-19. Symmetrical Sweep Center Frequency Adjustment

Description:

The symmetrical sweep controls are adjusted for a minimum frequency shift across the band when switching from CW to SYM.

Equipment:

Counter/Marker Generator HP 8600A

Procedure:

1. Set 8601A controls as follows:

CW/SWEEP	CW	RANGE	110
SYM SWEEP WIDTH	0	FREQUENCY	1.0 MHz

2. Connect the counter to the front panel AUX OUT jack and note counter reading.
3. Set CW/SWEEP switch to SYM and adjust SYM Fc MIN A9R120 to obtain the same counter reading as in CW (step 2).
4. Set CW/SWEEP switch back to CW.
5. Set FREQUENCY control to 50 MHz and note counter reading.
6. Set CW/SWEEP switch back to SYM and adjust SYM Fc MAX A9R117 to obtain the same counter reading as in CW (step 5).
7. Set CW/SWEEP switch back to CW.

ADJUSTMENTS

5-19. Symmetrical Sweep Center Frequency Adjustment (Cont)

8. Set FREQUENCY control to 110 MHz and record counter reading.
 9. Set CW/SWEEP switch to SYM and record counter reading.
 10. Compute:

$$\frac{(\text{freq in CW}) - (\text{freq in SYM})}{(\text{freq in CW})}$$
 11. Repeat steps 3 through 10 until answer is less than 0.5% (550 kHz).
 12. Repeat steps 3 through 11 until no further adjustment is required.
-

5-20. Sweep Width Adjustment

Description:

The symmetrical sweep circuitry is adjusted for a calibrated symmetrical sweep about the center frequency. The video sweep circuitry is adjusted for a minimum frequency shift when switching from VIDEO to CW mode.

Equipment:

Counter/Marker Generator HP 8600A

Procedure:

1. Set 8601A controls as follows:

CW SWEEP SYM	RANGE 11
SYM SWEEP WIDTH 0	SWEEP MODE MANUAL
2. Connect the counter to the front panel AUX OUT jack.
3. Tune 8601A FREQUENCY control for 5 MHz counter reading.
4. Set SYM SWEEP WIDTH to 1 MHz position (blue numbers).
5. Note frequency change on counter while rotating MANUAL control from fully clockwise to fully counterclockwise position. Adjust Δ SYM adjust A9R71 for a total frequency change of 1 MHz.
6. With MANUAL control fully counterclockwise, adjust the SYM CAL adjust A9R76 for a counter reading of 4.500 MHz. Rotate MANUAL control fully clockwise and counter should indicate 5.500 MHz.

NOTE

These two adjustments interact, so repeat steps 5 and 6 until no further adjustment is required.

7. Set 8601A CW/SWEEP to CW and note counter reading.
-

ADJUSTMENTS

5-20. Sweep Width Adjustment (Cont)

8. Turn MANUAL control full clockwise. Set CW/SWEEP to VIDEO and adjust VIDEO SWEEP STOP adjust A9R24 to obtain same counter reading as in CW (step 7).
9. Set CW/SWEEP back to CW and tune FREQUENCY to 0.1 MHz. Note counter reading.
10. Set CW/SWEEP to VIDEO and adjust VIDEO START adjust A9R34 to obtain same counter reading as in CW (step 9).
11. Repeat steps 7 through 10 until no further adjustment is required.



SECTION VI

REPLACEABLE PARTS

6-1. INTRODUCTION

6-2. This section contains information for ordering replaceable parts. Table 6-1 gives the meanings of the abbreviations and reference designations used in the table of replaceable parts.

6-3. Table 6-2 is the table of replaceable parts and is organized as follows:

1. Electrical assemblies and their component parts in alpha-numerical order by reference designation.

2. Chassis parts in alpha-numerical order by reference designation.

3. Miscellaneous parts.

4. Illustrated parts breakdown, if appropriate.

6-4. The information given for each part consists of:

1. The Hewlett-Packard part number.

2. The part number check digit.

3. Total quantity (TQ) in the instrument. Total quantity for each part is given only once — at the first appearance of the part number.

4. Description of the part.

5. Typical manufacturer of the part, in a five-digit code.

6. The manufacturer's number for the part.

6-5. Table 6-3 contains the names and addresses that correspond to the manufacturer's code numbers.

6-6. ORDERING INFORMATION

6-7. To order a part listed in the replaceable parts table, quote the Hewlett-Packard part number, indicate the quantity required, and address the order to the nearest Hewlett-Packard office.

6-8. To order a part that is not listed in the replaceable parts table, include the instrument model number, instrument serial number, the description and function of the part, and the number of parts required. Address the order to the nearest Hewlett-Packard office.

Table 6-1. Reference Designators and Abbreviations

REFERENCE DESIGNATORS							
A	= assembly	F	= fuse	P	= plug	V	= vacuum tube, neon bulb, photocell, etc.
B	= motor	FL	= Filter	Q	= transistor	VR	= voltage regulator
BT	= battery	J	= jack	R	= resistor	W	= cable
C	= capacitor	K	= relay	RT	= thermistor	X	= socket
CP	= coupler	L	= inductor	S	= switch	Y	= crystal
CR	= diode	LS	= loud speaker	T	= transformer	Z	= tuned cavity, network
DL	= delay line	M	= meter	TB	= terminal board		
DS	= device signaling (lamp)	MK	= microphone	TP	= test point		
E	= misc electronic part	MP	= mechanical part	U	= integrated circuit		

ABBREVIATIONS							
A	= amperes	H	= henries	N/O	= normally open	RMO	= rack mount only
AFC	= automatic frequency control	HDW	= hardware	NOM	= nominal	RMS	= root-mean square
AMPL	= amplifier	HEX	= hexagonal	NPO	= negative positive zero (zero temperature coef- ficient)	RWV	= reverse working voltage
BFO	= beat frequency oscilla- tor	HG	= mercury			S-B	= slow-blow
BE CU	= beryllium copper	HR	= hour(s)	NPN	= negative-positive- negative	SCR	= screw
BH	= binder head	Hz	= Hertz	NRFR	= not recommended for field re- placement	SE	= selenium
BP	= bandpass	IF	= intermediate freq	NSR	= not separately replaceable	SECT	= section(s)
BRS	= brass	IMPG	= impregnated			SEMICON	= semiconductor
BWO	= backward wave oscilla- tor	INCD	= incandescent	OBD	= order by description	SI	= silicon
		INCL	= include(s)	OH	= oval head	SIL	= silver
		INS	= insulation(ed)	OX	= oxide	SL	= slide
		INT	= internal	P	= peak	SPG	= spring
CCW	= counterclockwise	K	= kilo = 1000	PC	= printed circuit	SPL	= special
CER	= ceramic	LH	= left hand	PF	= picofarads = 10 ⁻¹² farads	SST	= Stainless steel
CMO	= cabinet mount only	LIN	= linear taper	PH BRZ	= phosphor bronze	SR	= split ring
COEF	= coefficient	LK WASH	= lock washer	PHL	= Phillips	STL	= steel
COM	= common	LOG	= logarithmic taper	PIV	= peak inverse voltage	TA	= tantalum
COMP	= composition	LPF	= low pass filter	PNP	= positive-negative- positive	TD	= time delay
COMPL	= complete	M	= milli = 10 ⁻³	P/O	= part of	TGL	= toggle
CONN	= connector	MEG	= meg = 10 ⁶	POLY	= polystrene	THD	= thread
CP	= cadmium plate	MET FLM	= metal film	PORC	= porcelain	TI	= titanium
CRT	= cathode-ray tube	MET OX	= metallic oxide	POS	= position(s)	TOL	= tolerance
CW	= clockwise	MFR	= manufacturer	POT	= potentiometer	TRIM	= trimmer
DEPC	= deposited carbon	MHz	= mega Hertz	PP	= peak-to-peak	TWT	= traveling wave tube
DR	= drive	MINAT	= miniature	PT	= point		
ELECT	= electrolytic	MOM	= momentary	PWV	= peak working volt- age	μ	= micro = 10 ⁻⁶
ENCAP	= encapsulated	MOS	= metalized substrate	RECT	= rectifier	VAR	= variable
EXT	= external	MTG	= mounting	RF	= radio frequency	VDCW	= dc working volts
F	= farads	MY	= "mylar"	RH	= round head or right hand	W/	= with
FH	= flat head	N	= nano (10 ⁻⁹)			W	= watts
FIL H	= Fillister head	N/C	= normally closed			WIV	= working inverse voltage
FXD	= fixed	NE	= neon			WW	= wirewound
G	= giga (10 ⁹)	NI PL	= nickel plate			W/O	= without
GE	= germanium						
GL	= glass						
GRD	= ground(ed)						

Table 6-2. REPLACEABLE PARTS

Reference Designation	HP Part Number	C D	Qty	Description	Mfr Code	Mfr Part Number
A1	08601-6072	0	1	DISCRIMINATOR ASSEMBLY (INCL C1-C4, J1-J3, A1A1 ASSY & COVER)	28480	08601-6072
A1	08601-6051	6	1	DISCRIMINATOR ASSEMBLY (OPT. 001, 002, 011 ONLY)	28480	08601-6051
A1	08601-2027	1	1	FRONT PANEL-DISC ASSEMBLY	28480	08601-2027
A1	08601-2017	0	1	BOX-DISC ASSEMBLY	28480	08601-2017
A1C1	0160-2152	7	1	CAPACITOR-PDTHRU 10PF 20% 500V CER	28480	0160-2152
A1C2	0160-2049	1	20	CAPACITOR-PDTHRU 5000PF +80 -20% 500V	33095	54-743-009-X5V0-502Z
A1C3	0160-2049	1	1	CAPACITOR-PDTHRU 5000PF +80 -20% 500V	33095	54-743-009-X5V0-502Z
A1C4	0160-2049	1	1	CAPACITOR-PDTHRU 5000PF +80 -20% 500V	33095	54-743-009-X5V0-502Z
A1J1	1250-0829	3	23	CONNECTOR-RF SMC M 3GL-HOLE-FR 50-OHM	28480	1250-0829
A1J2	1250-0829	3	3	CONNECTOR-RF SMC M 3GL-HOLE-FR 50-OHM	28480	1250-0829
A1J3	1250-0829	3	3	CONNECTOR-RF SMC M 3GL-HOLE-FR 50-OHM	28480	1250-0829
A1J4	1250-0829	3	3	CONNECTOR-RF SMC M 3GL-HOLE-FR 50-OHM (OPT. 001, 002, 011 ONLY)	28480	1250-0829
A1A1	08601-6042	7	1	BOARD ASSEMBLY-DISCRIMINATOR/DC AMPL.	28480	08601-6042
A1A1C1	0180-0116	1	4	CAPACITOR-FXD 6.8UF+-10% 35VDC TA	56289	150D685X9035B2
A1A1C2	0180-0116	1	1	CAPACITOR-FXD 6.8UF+-10% 35VDC TA	56289	150D685X9035B2
A1A1C3	0160-2327	8	3	CAPACITOR-FXD 1000PF +-20% 100VDC CER	51642	150-110-X5R-102M
A1A1C4	0160-2262	0	2	CAPACITOR-FXD 16PF +-5% 500VDC CER 0+-30	28480	0160-2262
A1A1C5	0160-2262	0	2	CAPACITOR-FXD 16PF +-5% 500VDC CER 0+-30	28480	0160-2262
A1A1C6	0121-0452	4	1	CAPACITOR-V TRMR-AIR 1.3-5.4PF 250V	74970	187-0103-005
A1A1C7	0180-0291	3	8	CAPACITOR-FXD 1UF+-10% 35VDC TA	56289	150D105X9035A2
A1A1C8	0160-0161	4	2	CAPACITOR-FXD .01UF +-10% 200VDC POLYE	28480	0160-0161
A1A1C9	0160-0298	8	2	CAPACITOR-FXD 1500PF +-10% 200VDC POLYE	28480	0160-0298
A1A1C10	0160-2201	7	3	CAPACITOR-FXD 51PF +-5% 300VDC WICA	28480	0160-2201
A1A1C11	0160-0303	6	1	CAPACITOR-FXD .15UF +-10% 200VDC POLYE	28480	0160-0303
A1A1C12	0180-0161	5	3	CAPACITOR-FXD 3.3UF+-10% 35VDC TA	00908	T1108335X035A8
A1A1C13	0180-0116	1	1	CAPACITOR-FXD 6.8UF+-10% 35VDC TA	56289	150D685X9035B2
A1A1CR1	1901-0535	9	3	DIODE-SCHOTTKY	28480	1901-0535
A1A1CR2	1901-0535	9	9	DIODE-SCHOTTKY	28480	1901-0535
A1A1CR3	1901-0535	9	9	DIODE-SCHOTTKY	28480	1901-0535
A1A1CR4	1902-3149	9	1	DIODE-ZNR 9.09V 5% DD=7 PD=.4M TC=+.057X	28480	1902-3149
A1A1CR5	1901-0033	2	43	DIODE-GEN PRP 180V 200MA DD=7	28480	1901-0033
A1A1K1	0490-0399	9	2	RELAY-REED 1A 100MA 12VDC-COIL 3VA	28480	0490-0399
A1A1L1	9100-1618	1	3	COIL-MLD 5.6UH 10% Q45 .155DX.375LG-NOM	28480	9100-1618
A1A1L2	9100-1618	1	1	COIL-MLD 5.6UH 10% Q45 .155DX.375LG-NOM	28480	9100-1618
A1A1Q1	1853-0422	0	2	TRANSISTOR PNP 2N4033 SI TO-39 PD=800MH	01295	2N4033
A1A1Q2	1854-0071	7	38	TRANSISTOR NPN SI PD=300MH FT=200MHZ	28480	1854-0071
A1A1Q3	1853-0422	0	4	TRANSISTOR PNP 2N4033 SI TO-39 PD=800MH	01295	2N4033
A1A1Q4	1853-0020	4	9	TRANSISTOR PNP SI PD=300MH FT=150MHZ	28480	1853-0020
A1A1Q5	1854-0221	9	6	TRANSISTOR-DUAL NPN PD=750MH	28480	1854-0221
A1A1Q6	1854-0071	7	1	TRANSISTOR NPN SI PD=300MH FT=200MHZ	28480	1854-0071
A1A1Q7	1854-0071	7	1	TRANSISTOR NPN SI PD=300MH FT=200MHZ	28480	1854-0071
A1A1Q8	1853-0075	9	1	TRANSISTOR-DUAL PNP PD=400MH	28480	1853-0075
A1A1Q9	1854-0009	1	5	TRANSISTOR NPN SI PD=300MH FT=600MHZ	04713	2N709
A1A1Q10	1854-0009	1	1	TRANSISTOR NPN SI PD=300MH FT=600MHZ	04713	2N709
A1A1Q11	1854-0009	1	1	TRANSISTOR NPN SI PD=300MH FT=600MHZ	04713	2N709
A1A1Q12	1854-0071	7	1	NOT ASSIGNED		
A1A1Q13	1854-0071	7	1	TRANSISTOR NPN SI PD=300MH FT=200MHZ	28480	1854-0071
A1A1R1	0757-0346	2	8	RESISTOR 10 1% .125W F TC=0+-100	24546	C4=1/8-T0=10R0=F
A1A1R2	0757-0346	2	2	RESISTOR 10 1% .125W F TC=0+-100	24546	C4=1/8-T0=10R0=F
A1A1R3	0698-3440	7	3	RESISTOR 196 1% .125W F TC=0+-100	24546	C4=1/8-T0=196R=F
A1A1R4	0698-3410	1	2	RESISTOR 3.16K 1% .5W F TC=0+-100	28480	0698-3410
A1A1R5	0698-4311	3	1	RESISTOR 1K 1% .5W F TC=0+-25 (SPEC. TEMP. COEFFICIENT OF 25 PPM/C.)	28480	0698-4311
A1A1R6	0698-6319	5	1	RESISTOR 300 1% .125W F TC=0+-25 (SPEC. TEMP. COEFFICIENT OF 25 PPM/C.)	03888	PME55=1/8-T9=300R=F
A1A1R7	0698-3274	5	1	RESISTOR 10K 1% .125W F TC=0+-25 (SPEC. TEMP. COEFFICIENT OF 25 PPM/C.)	28480	0698-3274
A1A1R8	0757-0428	1	6	RESISTOR 1.62K 1% .125W F TC=0+-100 (SPEC. TEMP. COEFFICIENT OF 25 PPM/C.)	24546	C4=1/8-T0=1621=F
A1A1R9	0698-0082	7	5	RESISTOR 464 1% .125W F TC=0+-100 (SPEC. TEMP. COEFFICIENT OF 25 PPM/C.)	24546	C4=1/8-T0=4640=F
A1A1R10	0757-0421	4	2	RESISTOR 825 1% .125W F TC=0+-100 (SPEC. TEMP. COEFFICIENT OF 25 PPM/C.)	24546	C4=1/8-T0=825R=F
A1A1R11	0757-0424	7	1	RESISTOR 1.1K 1% .125W F TC=0+-100	24546	C4=1/8-T0=1101=F
A1A1R12	0698-5674	3	1	RESISTOR 5.62K 1% .125W F TC=0+-25 (SPEC. TEMP. COEFFICIENT OF 25 PPM/C.)	28480	0698-5674
A1A1R13	0698-5133	9	1	RESISTOR 3.16K 1% .125W F TC=0+-25	28480	0698-5133
A1A1R14	0757-0419	0	4	RESISTOR 681 1% .125W F TC=0+-100	24546	C4=1/8-T0=681R=F
A1A1R15	0757-0419	0	4	RESISTOR 681 1% .125W F TC=0+-100	24546	C4=1/8-T0=681R=F

See introduction to this section for ordering information
*Indicates factory selected value

Table 6-2. REPLACEABLE PARTS

Reference Designation	HP Part Number	C D	Qty	Description	Mfr Code	Mfr Part Number
A1A1R16	0757-0419	0		RESISTOR 681 1% .125W F TC0+/-100	24546	C4=1/8-T0=681R-F
A1A1R17	0757-0442	9	42	RESISTOR 10K 1% .125W F TC0+/-100	24546	C4=1/8-T0=1002-F
A1A1R18-			6			
A1A1R25				NCT ASSIGNED		
A1A1R26	0757-0465	6	12	RESISTOR 100K 1% .125W F TC0+/-100	24546	C4=1/8-T0=1003-F
A1A1R27	0757-0394	0	10	RESISTOR 51.1 1% .125W F TC0+/-100	24546	C4=1/8-T0=51R1-F
A1A1R28	0698-3459	8	3	RESISTOR 383K 1% .125W F TC0+/-100	28480	0698-3459
A1A1R29	2100-3253	7	4	RESISTOR-TRMR 50K 10% C TOP-ADJ 1=TRN	28480	2100-3253
A1A1R30	0757-0461	2	1	RESISTOR 68.1K 1% .125W F TC0+/-100	24546	C4=1/8-T0=6812-F
A1A1R31	0757-0394	0		RESISTOR 51.1 1% .125W F TC0+/-100	24546	C4=1/8-T0=51R1-F
A1A1R32	0757-0280	3		RESISTOR 1K 1% .125W F TC0+/-100	24546	C4=1/8-T0=1001-F
A1A1R33	0757-0420	3	3	RESISTOR 750 1% .125W F TC0+/-100	24546	C4=1/8-T0=751-F
A1A1R34	0698-3156	2	5	RESISTOR 14.7K 1% .125W F TC0+/-100	24546	C4=1/8-T0=1472-F
A1A1R35	0757-0418	9	3	RESISTOR 619 1% .125W F TC0+/-100	24546	C4=1/8-T0=619R-F
A1A1R36	0698-3406	5	1	RESISTOR 1.33K 1% .5W F TC0+/-100	28480	0698-3406
A1A1R37	0757-0280	3		RESISTOR 1K 1% .125W F TC0+/-100	24546	C4=1/8-T0=1001-F
A1A1R38	0757-0442	9		RESISTOR 10K 1% .125W F TC0+/-100	24546	C4=1/8-T0=1002-F
A1A1R39	0757-0280	3		RESISTOR 1K 1% .125W F TC0+/-100	24546	C4=1/8-T0=1001-F
A1A1R40	0757-0317	7	7	RESISTOR 1.33K 1% .125W F TC0+/-100	24546	C4=1/8-T0=1331-F
A1A1R41	0757-0401	0	14	RESISTOR 100 1% .125W F TC0+/-100	24546	C4=1/8-T0=101-F
A1A1R42	0757-0317	7		RESISTOR 1.33K 1% .125W F TC0+/-100	24546	C4=1/8-T0=1331-F
A1A1R43	0757-0833	2	2	RESISTOR 5.11K 1% .5W F TC0+/-100	28480	0757-0833
A1A1R44	0757-0833	2	2	RESISTOR 5.11K 1% .5W F TC0+/-100	28480	0757-0833
A1A1R45	0698-3442	9	2	RESISTOR 237 1% .125W F TC0+/-100	24546	C4=1/8-T0=237R-F
A1A1R46	0757-0280	3		RESISTOR 1K 1% .125W F TC0+/-100	24546	C4=1/8-T0=1001-F
A1A1R47	0757-0442	9		RESISTOR 10K 1% .125W F TC0+/-100	24546	C4=1/8-T0=1002-F
A1A1R48	0757-0280	3		RESISTOR 1K 1% .125W F TC0+/-100	24546	C4=1/8-T0=1001-F
A1A1R49	0757-0280	3		RESISTOR 1K 1% .125W F TC0+/-100	24546	C4=1/8-T0=1001-F
A1A1R50	0757-0317	7		RESISTOR 1.33K 1% .125W F TC0+/-100	24546	C4=1/8-T0=1331-F
A1A1R51	0757-0280	3		RESISTOR 1K 1% .125W F TC0+/-100	24546	C4=1/8-T0=1001-F
A1A1R52	0698-3260	9	4	RESISTOR 464K 1% .125W F TC0+/-100	28480	0698-3260
A1A1R53	0698-3458	7	2	RESISTOR 348K 1% .125W F TC0+/-100	28480	0698-3458
A2	08601-60117	5	1	DIVIDER ASSEMBLY (INCL C1-C4, J1-J3, A2A1 ASSY & COVER)	28480	08601-60117
A2	08601-20099	8	1	FRONT PANEL-DIVIDER ASSEMBLY	28480	08601-20099
A2	08601-2016	8	3	BOX-SHIELD	28480	08601-2016
A2C1	0160-2049	1		CAPACITOR-FDTHRU 5000PF +80 -20% 500V	33095	54-743-009-X5V0-502Z
A2C2	0160-2049	1		CAPACITOR-FDTHRU 5000PF +80 -20% 500V	33095	54-743-009-X5V0-502Z
A2C3	0160-2049	1		CAPACITOR-FDTHRU 5000PF +80 -20% 500V	33095	54-743-009-X5V0-502Z
A2C4	0160-2049	1		CAPACITOR-FDTHRU 5000PF +80 -20% 500V	33095	54-743-009-X5V0-502Z
A2J1	1250-0829	3		CONNECTOR-RF SMC M 8GL-HOLE-FR 50-DHM	28480	1250-0829
A2J2	1250-0829	3		CONNECTOR-RF SMC M 8GL-HOLE-FR 50-DHM	28480	1250-0829
A2J3	1250-0829	3		CONNECTOR-RF SMC M 8GL-HOLE-FR 50-DHM	28480	1250-0829
A2A1	08601-60116	4	1	BOARD ASSEMBLY-DIVIDER	28480	08601-60116
A2A1C1	0160-0197	8	13	CAPACITOR-FXD 2.2UF+/-10% 20VDC TA	56289	150D225X9020A2
A2A1C2	0160-0197	8		CAPACITOR-FXD 2.2UF+/-10% 20VDC TA	56289	150D225X9020A2
A2A1C3	0160-2055	9	17	CAPACITOR-FXD .01UF +80-20% 100VDC CER	28480	0160-2055
A2A1C4	0160-0197	8		CAPACITOR-FXD 2.2UF+/-10% 20VDC TA	56289	150D225X9020A2
A2A1C5	0160-0197	8		CAPACITOR-FXD 2.2UF+/-10% 20VDC TA	56289	150D225X9020A2
A2A1C6	0160-2055	9		CAPACITOR-FXD .01UF +80-20% 100VDC CER	28480	0160-2055
A2A1C7	0160-0127	2	3	CAPACITOR-FXD 1UF +/-20% 25VDC CER	28480	0160-0127
A2A1C8	0160-0127	2		CAPACITOR-FXD 1UF +/-20% 25VDC CER	28480	0160-0127
A2A1C9	0160-2055	9		CAPACITOR-FXD .01UF +80-20% 100VDC CER	28480	0160-2055
A2A1C10	0160-0198	5	1	CAPACITOR-FXD 200PF +/-5% 300VDC MICA	72136	DM15P201J0300MV1CR
A2A1C11	0160-0197	8		CAPACITOR-FXD 2.2UF+/-10% 20VDC TA	56289	150D225X9020A2
A2A1C12	0160-0374	3	5	CAPACITOR-FXD 10UF+/-10% 20VDC TA	56289	150D106X9020B2
A2A1C13	0160-0127	2		CAPACITOR-FXD 1UF +/-20% 25VDC CER	28480	0160-0127
A2A1CR1	1901-0743	1	4	DIODE-PWR RECT 1N4004 400V 1A DO-41	01295	1N4004
A2A1CR2	1901-0743	1		DIODE-PWR RECT 1N4004 400V 1A DO-41	01295	1N4004
A2A1CR3	1901-0743	1		DIODE-PWR RECT 1N4004 400V 1A DO-41	01295	1N4004
A2A1CR4	1901-0743	1		DIODE-PWR RECT 1N4004 400V 1A DO-41	01295	1N4004
A2A1L1	9100-0368	6	5	COIL-MLD 330NH 10% Q#28 .095DX.375LG-NOM	28480	9100-0368
A2A1L2	9140-0237	2	3	COIL-MLD 200UH 5% Q#65 .155DX.375LG-NOM	28480	9140-0237
A2A1L3	9100-1618	1		COIL-MLD 5.6UH 10% Q#45 .155DX.375LG-NOM	28480	9100-1618
A2A1L4	9100-1624	9	1	COIL-MLD 30UH 5% Q#65 .155DX.375LG-NOM	28480	9100-1624
A2A1Q1	1853-0034	0	2	TRANSISTOR PNP 81 T0=18 PD=360MW	28480	1853-0034
A2A1Q2	1853-0034	0		TRANSISTOR PNP 81 T0=18 PD=360MW	28480	1853-0034
A2A1Q3	1854-0345	8	13	TRANSISTOR PNP 2N5179 81 T0=72 PD=200MW	047.3	2N5179
A2A1R1	0757-0399	5	2	RESISTOR 82.5 1% .125W F TC0+/-100	24546	C4=1/8-T0=82R5-F
A2A1R2	0698-3444	1	3	RESISTOR 316 1% .125W F TC0+/-100	24546	C4=1/8-T0=316R-F
A2A1R3	0757-0394	0		RESISTOR 51.1 1% .125W F TC0+/-100	24546	C4=1/8-T0=51R1-F
A2A1R4	0757-0394	0		RESISTOR 51.1 1% .125W F TC0+/-100	24546	C4=1/8-T0=51R1-F
A2A1R5	0698-3441	8	7	RESISTOR 215 1% .125W F TC0+/-100	24546	C4=1/8-T0=215R-F

See introduction to this section for ordering information
 *Indicates factory selected value

Table 6-2. REPLACEABLE PARTS

Reference Designation	HP Part Number	C D	Qty	Description	Mfr Code	Mfr Part Number
A2A1R6	0698-3432	7	3	RESISTOR 26.1 1% .125W F TC0+/-100	03888	PM55=1/8-T0=26R1=F
A2A1R7	0757-0280	3	48	RESISTOR 1K 1% .125W F TC0+/-100	24546	C4=1/8-T0=1001=F
A2A1R8	0698-3444	1		RESISTOR 316 1% .125W F TC0+/-100	24546	C4=1/8-T0=316R=F
A2A1R9	0757-0280	3		RESISTOR 1K 1% .125W F TC0+/-100	24546	C4=1/8-T0=1001=F
A2A1R10	0698-3432	7		RESISTOR 26.1 1% .125W F TC0+/-100	03888	PM55=1/8-T0=26R1=F
A2A1R11	0698-3441	8		RESISTOR 215 1% .125W F TC0+/-100	24546	C4=1/8-T0=215R=F
A2A1R12	0757-0280	3		RESISTOR 1K 1% .125W F TC0+/-100	24546	C4=1/8-T0=1001=F
A2A1R13	0757-0346	2		RESISTOR 10 1% .125W F TC0+/-100	24546	C4=1/8-T0=10R0=F
A2A1R14	0757-0401	0		RESISTOR 100 1% .125W F TC0+/-100	24546	C4=1/8-T0=101=F
A2A1R15	0757-0442	9		RESISTOR 10K 1% .125W F TC0+/-100	24546	C4=1/8-T0=100Z=F
A2A1R16	0757-0280	3		RESISTOR 1K 1% .125W F TC0+/-100	24546	C4=1/8-T0=1001=F
A2A1U1	1920-1383	5	1	IC CNTR ECL BCD POS=EDGE-TRIG	04713	MC10138L
A2A1U2	1920-0367	7	1	IC PP TTL H J=K M/S PULSE PRESET/CLEAR	01295	8N74H72N
A2A1VR1	1902-3024	9	1	DIODE=ZNR 2.87V 5% DO-7 PDM.4W TCR=.07X	28480	1902-3024
A3	08601-6003	5	1	LOOP AMPLIFIER ASSEMBLY (DOES NOT INCLUDE A3A1E1) (INCL C1=C4, J1=J4, A3A1, A3A2 ASSY & COVER)	28480	08601-6003
A3	08601-2029	5	1	FRONT PANEL=LOOP AMPLIFIER ASSEMBLY	28480	08601-2029
A3	08601-2016	8		BOX=SHIELD	28480	08601-2016
A3	08698-0013	5	2	COVER=CAN BOTTOM	28480	08698-0013
A3C1	0160-2049	1		CAPACITOR=FDTHRU 5000PF +80 -20% 500V	33095	54-743-009-X5V0-502Z
A3C2	0160-2049	1		CAPACITOR=FDTHRU 5000PF +80 -20% 500V	33095	54-743-009-X5V0-502Z
A3C3	0160-2049	1		CAPACITOR=FDTHRU 5000PF +80 -20% 500V	33095	54-743-009-X5V0-502Z
A3C4	0160-2049	1		CAPACITOR=FDTHRU 5000PF +80 -20% 500V	33095	54-743-009-X5V0-502Z
A3J1	1250-0829	3		CONNECTOR=RF 8MC M 8GL-HOLE=FR 50-OHM	28480	1250-0829
A3J2	1250-0829	3		CONNECTOR=RF 8MC M 8GL-HOLE=FR 50-OHM	28480	1250-0829
A3J3	1250-0829	3		CONNECTOR=RF 8MC M 8GL-HOLE=FR 50-OHM	28480	1250-0829
A3J4	1250-0829	3		CONNECTOR=RF 8MC M 8GL-HOLE=FR 50-OHM	28480	1250-0829
A3A1	08601-6023	7	1	BOARD ASSEMBLY=LOOP AMPLIFIER (DOES NOT INCLUDE A3A1E1)	28480	08601-6023
A3A1C1	0160-0291	3		CAPACITOR=FXD .1UF +/-10% 35VDC TA	56289	150D105X9035A2
A3A1C2	0160-2150	5	3	CAPACITOR=FXD 33PF +/-5% 300VDC MICA	28480	0160-2150
A3A1C3	0160-2200	6	2	CAPACITOR=FXD 43PF +/-5% 300VDC MICA	28480	0160-2200
A3A1C4	0160-0191	8	3	CAPACITOR=FXD 56PF +/-5% 300VDC MICA	72136	DM15E560J0300WV1CR
A3A1C5	0160-2200	6		CAPACITOR=FXD 43PF +/-5% 300VDC MICA	28480	0160-2200
A3A1C6	0160-2150	5		CAPACITOR=FXD 33PF +/-5% 300VDC MICA	28480	0160-2150
A3A1C7	0160-2055	9		CAPACITOR=FXD .01UF +80-20% 100VDC CER	28480	0160-2055
A3A1C8	0160-0174	9	3	CAPACITOR=FXD .47UF +80-20% 25VDC CER	28480	0160-0174
A3A1C9	0160-1735	2	7	CAPACITOR=FXD .22UF +/-10% 35VDC TA	56289	150D224X9035A2
A3A1C10	0160-2150	5		CAPACITOR=FXD 33PF +/-5% 300VDC MICA	28480	0160-2150
A3A1C11	0160-0174	9		CAPACITOR=FXD .47UF +80-20% 25VDC CER	28480	0160-0174
A3A1C12	0160-1735	2	2	CAPACITOR=FXD .22UF +/-10% 35VDC TA	56289	150D224X9035A2
A3A1C13	0160-1735	2	2	CAPACITOR=FXD .22UF +/-10% 35VDC TA	56289	150D224X9035A2
A3A1C14	0160-2055	9		CAPACITOR=FXD .01UF +80-20% 100VDC CER	28480	0160-2055
A3A1C15	0160-2307	4	1	CAPACITOR=FXD 47PF +/-5% 300VDC MICA	28480	0160-2307
A3A1C16	0160-2202	8	1	CAPACITOR=FXD 75PF +/-5% 300VDC MICA	28480	0160-2202
A3A1C17	0160-2216	4	1	CAPACITOR=FXD 620PF +/-5% 300VDC MICA	28480	0160-2216
A3A1C18	0160-1735	2		CAPACITOR=FXD .22UF +/-10% 35VDC TA	56289	150D224X9035A2
A3A1C19	0160-2201	7		CAPACITOR=FXD 51PF +/-5% 300VDC MICA	28480	0160-2201
A3A1C20	0160-2055	9		CAPACITOR=FXD .01UF +80-20% 100VDC CER	28480	0160-2055
A3A1C21	0160-2236	8	1	CAPACITOR=FXD .1PF +/-25PF 500VDC CER	28480	0160-2236
A3A1C22	0160-1735	2		CAPACITOR=FXD .22UF +/-10% 35VDC TA	56289	150D224X9035A2
A3A1C23	0160-1743	2	7	CAPACITOR=FXD .1UF +/-10% 35VDC TA	56289	150D104X9035A2
A3A1C24	0160-0153	4	3	CAPACITOR=FXD 1000PF +/-10% 200VDC POLYE	28480	0160-0153
A3A1C25	0160-0153	4		CAPACITOR=FXD 1000PF +/-10% 200VDC POLYE	28480	0160-0153
A3A1C26	0160-1735	2		CAPACITOR=FXD .22UF +/-10% 35VDC TA	56289	150D224X9035A2
A3A1C27	0160-2055	9		CAPACITOR=FXD .01UF +80-20% 100VDC CER	28480	0160-2055
A3A1C28	0160-0197	1	1	CAPACITOR=FXD .22UF +/-10% 26VDC	56289	150D225X902A2
A3A1C29	0160-2055	9		CAPACITOR=FXD .01UF +80-20% 100VDC CER	28480	0160-2055
A3A1CR1	1901-0456	3	1	NOT ASSIGNED	28480	1901-0456
A3A1CR2	1901-0033	2		DIODE=SCOTTKY	28480	1901-0033
A3A1CR3	1901-0033	2		DIODE=GEN PRP 180V 200MA DO-7	28480	1901-0033
A3A1CR4	1901-0033	2		DIODE=GEN PRP 180V 200MA DO-7	28480	1901-0033
A3A1E1	5086-7010	3	2	INTEGRATED CIRCUIT	28480	5086-7010
	5086-7111	5		REQUIRES EXCHANGE, 5086-7111=REPLACEMENT	28480	5086-7111
A3A1L1	9140-0096	1	3	COIL=MLD 1UH 10% Q=50 .155DX, 375LG=NDM	28480	9140-0096
A3A1L2	9100-1613	6	1	COIL=MLD 470NH 20% Q=45 .155DX, 375LG=NDM	28480	9100-1613
A3A1L3				NSR, PART OF BD. ASSY, TYPICAL VALUE 40NH		
A3A1L4				NSR, PART OF BD. ASSY, TYPICAL VALUE 40NH		
A3A1L5				NSR, PART OF BD. ASSY, TYPICAL VALUE 40NH		

See introduction to this section for ordering information
*Indicates factory selected value

Table 6-2. REPLACEABLE PARTS

Reference Designation	HP Part Number	C D	Qty	Description	Mfr Code	Mfr Part Number
ASA1L6				NSR, PART OF BD. ASSY, TYPICAL VALUE 40NH		
ASA1L7	9140-0096	1		COIL=MLD 1UH 10% Q=50 .155DX, 375LG=NOM	28480	9140-0096
ASA1L8	9140-0096	1		COIL=MLD 1UH 10% Q=50 .155DX, 375LG=NOM	28480	9140-0096
ASA1L9	9100-1622	7	1	COIL=MLD 24UH 5% Q=60 .155DX, 375LG=NOM	28480	9100-1622
ASA1L10	9100-1610	3	6	COIL=MLD 150NH 20% Q=50 .155DX, 375LG=NOM	28480	9100-1610
ASA1Q1	1854-0071	7		TRANSISTOR NPN SI PD=300MH FT=200MHZ	28480	1854-0071
ASA1Q2	1854-0247	9	1	TRANSISTOR NPN SI T0=39 PD=1W FT=800MHZ	28480	1854-0247
ASA1Q3	1855-0082	2	1	TRANSISTOR J=FET P=CHAN D=MODE SI	28480	1855-0082
ASA1Q4	1854-0071	7		TRANSISTOR NPN SI PD=300MH FT=200MHZ	28480	1854-0071
ASA1Q5	1854-0071	7		TRANSISTOR NPN SI PD=300MH FT=200MHZ	28480	1854-0071
ASA1R1	0757-0280	3		RESISTOR 1K 1% .125W F TC=0+-100	24546	C4=1/8-T0=1001-F
ASA1R2*	0757-0403	2	2	RESISTOR 121 1% .125W F TC=0+-100	24546	C4=1/8-T0=121R-F
ASA1R3*	0698-3431	6	2	RESISTOR 23.7 1% .125W F TC=0+-100	03688	PME55=1/8-T0=237R-F
ASA1R4	0757-0346	2		RESISTOR 10 1% .125W F TC=0+-100	24546	C4=1/8-T0=10R0-F
ASA1R5	0757-0280	3		RESISTOR 1K 1% .125W F TC=0+-100	24546	C4=1/8-T0=1001-F
ASA1R6	0757-0280	3		RESISTOR 1K 1% .125W F TC=0+-100	24546	C4=1/8-T0=1001-F
ASA1R7	0757-0394	0		RESISTOR 51.1 1% .125W F TC=0+-100	24546	C4=1/8-T0=51R1-F
ASA1R8	0698-3441	8		RESISTOR 215 1% .125W F TC=0+-100	24546	C4=1/8-T0=215R-F
ASA1R9	0757-0401	0		RESISTOR 100 1% .125W F TC=0+-100	24546	C4=1/8-T0=101-F
ASA1R10	0698-3432	7		RESISTOR 26.1 1% .125W F TC=0+-100	03688	PME55=1/8-T0=26R1-F
ASA1R11	0698-3443	0	3	RESISTOR 287 1% .125W F TC=0+-100	24546	C4=1/8-T0=287R-F
ASA1R12	0698-3136	8	1	RESISTOR 17.8K 1% .125W F TC=0+-100	24546	C4=1/8-T0=1782-F
ASA1R13	0757-0440	7	4	RESISTOR 7.5K 1% .125W F TC=0+-100	24546	C4=1/8-T0=7501-F
ASA1R14*	0757-0424	7	3	RESISTOR 1.1K 1% .125W F TC=0+-100	24546	C4=1/8-T0=1101-F
ASA1R15	0757-0274	5	1	RESISTOR 1.21K 1% .125W F TC=0+-100	24546	C4=1/8-T0=1213-F
ASA1R16	0757-0465	6		RESISTOR 100K 1% .125W F TC=0+-100	24546	C4=1/8-T0=1003-F
ASA1R17	0698-3260	9		RESISTOR 464K 1% .125W F TC=0+-100	28480	0698-3260
ASA1R18	0698-3458	7		RESISTOR 348K 1% .125W F TC=0+-100	28480	0698-3458
ASA1R19	0698-3153	9	2	RESISTOR 3.83K 1% .125W F TC=0+-100	24546	C4=1/8-T0=3831-F
ASA1R20	0757-0439	4	2	RESISTOR 6.81K 1% .125W F TC=0+-100	24546	C4=1/8-T0=6811-F
ASA1R21	0757-0289	2	2	RESISTOR 13.3K 1% .125W F TC=0+-100	19701	MF4C1/8-T0=1332-F
ASA1R22	0698-3157	3	4	RESISTOR 19.6K 1% .125W F TC=0+-100	24546	C4=1/8-T0=1962-F
ASA1R23	0757-0442	9		RESISTOR 10K 1% .125W F TC=0+-100	24546	C4=1/8-T0=1002-F
ASA1R24	0757-0442	9		RESISTOR 10K 1% .125W F TC=0+-100	24546	C4=1/8-T0=1002-F
ASA1R25	0757-0420	3		RESISTOR 750 1% .125W F TC=0+-100	24546	C4=1/8-T0=751-F
ASA1R26	0757-0442	9		RESISTOR 10K 1% .125W F TC=0+-100	24546	C4=1/8-T0=1002-F
ASA1R27	0757-0280	3		RESISTOR 1K 1% .125W F TC=0+-100	24546	C4=1/8-T0=1001-F
ASA1R28	0698-3157	3		RESISTOR 19.6K 1% .125W F TC=0+-100	24546	C4=1/8-T0=1962-F
ASA1R29	0698-3440	7		RESISTOR 196 1% .125W F TC=0+-100	24546	C4=1/8-T0=196R-F
ASA1R30	0757-0394	0		RESISTOR 51.1 1% .125W F TC=0+-100	24546	C4=1/8-T0=51R1-F
ASA1Y1	0410-0170	6	1	CRYSTAL=QUARTZ 5.000 MHZ	28480	0410-0170
ASA2A1	08601-6041	5	2	MIXER ASSEMBLY	28480	08601-6041
ASA2A1	08698-0007	2	2	BOX=MIXER	28480	08698-0007
ASA2A1	08698-0009	6	2	PLATE=INSULATOR	28480	08698-0009
ASA2A1C1	0160-2264	2	3	CAPACITOR=FXD 20PF +-5% 500VDC CER 0+-30	28480	0160-2264
ASA2A1C2	0150-0021	4	4	CAPACITOR=FXD .47PF +-5% 500VDC TI D1DX	28480	0150-0021
ASA2A1C3	0150-0021	4	4	CAPACITOR=FXD .47PF +-5% 500VDC TI D1DX	28480	0150-0021
ASA2A1C4	0180-1743	2		CAPACITOR=FXD .1UF+-10% 35VDC TA	56289	150D104X9035A2
ASA2A1C5	0160-0301	4	2	CAPACITOR=FXD .012UF +-10% 200VDC POLYE	28480	0160-0301
ASA2A1CR1	1901-0557	5	2	DIODE=ARRAY VF DIFF=5MV	28480	1901-0557
ASA2A1L1	9100-0368	6		COIL=MLD 330NH 10% Q=28 .095DX, 25LG=NOM	28480	9100-0368
ASA2A1L2	9100-0368	6		COIL=MLD 330NH 10% Q=28 .095DX, 25LG=NOM	28480	9100-0368
ASA2A1L3	08698-6013	1	2	COIL=VAR	28480	08698-6013
ASA2A1L4	9140-0094	9	3	COIL=MLD 680NH 10% Q=50 .155DX, 375LG=NOM	28480	9140-0094
ASA2A1L5	9100-2247	4	6	COIL=MLD 100NH 10% Q=34 .095DX, 25LG=NOM	28480	9100-2247
ASA2A1R1				NOT ASSIGNED		
ASA2A1R2	0698-3441	8		RESISTOR 215 1% .125W F TC=0+-100	24546	C4=1/8-T0=215R-F
ASA2A1T1	08698-6012	9	2	TRANSFORMER=MIXER	28480	08698-6012
A4	08601-6004	7	1	FIXED OSCILLATOR ASSEMBLY (INCL C1,C2,J1-J3,A4A1=A4A3 ASSYS & COVER)	28480	08601-6004
A4	08601-2030	8	1	FRONT PANEL=FXD OSCILLATOR ASSEMBLY	28480	08601-2030
A4	08601-2016	8		BOX=SHIELD	28480	08601-2016
A4	08698-0013	5		COVER=CAN BOTTOM	28480	08698-0013
A4	08698-0031	3	1	BRACKET=RETAINING	28480	08698-0031
A4C1	0160-2049	1		CAPACITOR=FDTHRU 5000PF +60 -20% 500V	33095	50-743-009-X5V0-5022
A4C2	0160-2049	1		CAPACITOR=FDTHRU 5000PF +60 -20% 500V	33095	50-743-009-X5V0-5022
A4J1	1250-0829	3		CONNECTOR=RF 8MC M 3GL=HOLE=FR 30-OHM	28480	1250-0829
A4J2	1250-0829	3		CONNECTOR=RF 8MC M 3GL=HOLE=FR 30-OHM	28480	1250-0829
A4J3	1250-0829	3		CONNECTOR=RF 8MC M 3GL=HOLE=FR 30-OHM	28480	1250-0829

See introduction to this section for ordering information
*Indicates factory selected value

Table 6-2. REPLACEABLE PARTS

Reference Designation	HP Part Number	C D	Qty	Description	Mfr Code	Mfr Part Number	
A4A1	08601-6024	9	1	BOARD ASSEMBLY-FIXED OSCILLATOR	28480	08601-6024	
A4A1C1	0150-0050	9	24	CAPACITOR-FXD 1000PF +80-20% 1KVDC CER	28480	0150-0050	
A4A1C2	0160-2327	8		CAPACITOR-FXD 1000PF +-20% 100VDC CER	31642	150-110-X5R-102M	
A4A1C3	0150-0050	9		CAPACITOR-FXD 1000PF +80-20% 1KVDC CER	28480	0150-0050	
A4A1C4	0150-0050	9		CAPACITOR-FXD 1000PF +80-20% 1KVDC CER	28480	0150-0050	
A4A1C5	0160-2327	8		CAPACITOR-FXD 1000PF +-20% 100VDC CER	31642	150-110-X5R-102M	
A4A1C6	0160-2253	9	1	CAPACITOR-FXD 6.8PF +-25% 500VDC CER	28480	0160-2253	
A4A1C7*	0160-2259	5	1	CAPACITOR-FXD 12PF +-5% 500VDC CER 0+-30	28480	0160-2259	
A4A1C8	0160-2261	9	1	CAPACITOR-FXD 15PF +-5% 500VDC CER 0+-30	28480	0160-2261	
A4A1C9	0160-2266	4	12	CAPACITOR-FXD 24PF +-5% 500VDC CER 0+-30	28480	0160-2266	
A4A1C10	0160-2257	3	5	CAPACITOR-FXD 10PF +-5% 500VDC CER 0+-60	28480	0160-2257	
A4A1C11	0160-2266	4	1	CAPACITOR-FXD 24PF +-5% 500VDC CER 0+-30	28480	0160-2266	
A4A1C12	0160-2241	5		CAPACITOR-FXD 2.2PF +-25% 500VDC CER	28480	0160-2241	
A4A1C13	0160-2055	9		CAPACITOR-FXD .01UF +80-20% 100VDC CER	28480	0160-2055	
A4A1C14	0160-2139	0		4	CAPACITOR-FXD 220PF +80-20% 1KVDC CER	28480	0160-2139
A4A1C15	0160-2260	8		2	CAPACITOR-FXD 13PF +-5% 500VDC CER 0+-30	28480	0160-2260
A4A1C16	0160-2055	9	2	CAPACITOR-FXD .01UF +80-20% 100VDC CER	28480	0160-2055	
A4A1C17	0160-2260	8		CAPACITOR-FXD 13PF +-5% 500VDC CER 0+-30	28480	0160-2260	
A4A1C18	0160-2055	9		CAPACITOR-FXD .01UF +80-20% 100VDC CER	28480	0160-2055	
A4A1C19	0160-2139	0		CAPACITOR-FXD 220PF +80-20% 1KVDC CER	28480	0160-2139	
A4A1C20	0160-2264	2		CAPACITOR-FXD 20PF +-5% 500VDC CER 0+-30	28480	0160-2264	
A4A1C21	0160-2139	0	3	CAPACITOR-FXD 220PF +80-20% 1KVDC CER	28480	0160-2139	
A4A1C22	0160-2257	3		CAPACITOR-FXD 10PF +-5% 500VDC CER 0+-60	28480	0160-2257	
A4A1C23	0160-2055	9		CAPACITOR-FXD .01UF +80-20% 100VDC CER	28480	0160-2055	
A4A1C24	0160-2055	9		CAPACITOR-FXD .01UF +80-20% 100VDC CER	28480	0160-2055	
A4A1C25	0150-0050	9		CAPACITOR-FXD 1000PF +80-20% 1KVDC CER	28480	0150-0050	
A4A1L1	9100-2249	6	2	COIL-MLD 150NH 10% Q#34 .095DX.25LG-NOM	28480	9100-2249	
A4A1L2	9140-0158	6		COIL-MLD 1UH 10% Q#32 .095DX.25LG-NOM	28480	9140-0158	
A4A1L3	9100-2249	6		COIL-MLD 150NH 10% Q#34 .095DX.25LG-NOM	28480	9100-2249	
A4A1L4	9100-2247	4		COIL-MLD 100NH 10% Q#34 .095DX.25LG-NOM	28480	9100-2247	
A4A1L5	9100-2247	4		COIL-MLD 100NH 10% Q#34 .095DX.25LG-NOM	28480	9100-2247	
A4A1L6	09601-8004	9	1	COIL-VAR	28480	09601-8004	
A4A1L7	9140-0158	6	1	COIL-MLD 1UH 10% Q#32 .095DX.25LG-NOM	28480	9140-0158	
A4A1L8	9100-2247	4		COIL-MLD 100NH 10% Q#34 .095DX.25LG-NOM	28480	9100-2247	
A4A1L9	9100-2247	4		COIL-MLD 100NH 10% Q#34 .095DX.25LG-NOM	28480	9100-2247	
A4A1L10	9140-0210	1		COIL-MLD 100UH 5% Q#50 .155DX.375LG-NOM	28480	9140-0210	
A4A1L11	9140-0158	6		COIL-MLD 1UH 10% Q#32 .095DX.25LG-NOM	28480	9140-0158	
A4A1O1	1854-0345	8	8	TRANSISTOR NPN 2N5179 SI TO-72 PD=200MW	04713	2N5179	
A4A1O2	1854-0345	8		TRANSISTOR NPN 2N5179 SI TO-72 PD=200MW	04713	2N5179	
A4A1O3	1854-0345	8		TRANSISTOR NPN 2N5179 SI TO-72 PD=200MW	04713	2N5179	
A4A1O4	1854-0071	7		NOT ASSIGNED			
A4A1O5	1854-0071	7		TRANSISTOR NPN SI PD=300MW FT=200MHZ	28480	1854-0071	
A4A1O6	1854-0345	8	8	TRANSISTOR NPN 2N5179 SI TO-72 PD=200MW	04713	2N5179	
A4A1O7	1854-0345	8		TRANSISTOR NPN 2N5179 SI TO-72 PD=200MW	04713	2N5179	
A4A1R1	0698-3441	8	1	RESISTOR 215 1% .125W F TC0+-100	24546	C4-1/8-T0-215R-F	
A4A1R2	0757-0278	7		RESISTOR 1.78K 1% .125W F TC0+-100	24546	C4-1/8-T0-1781-F	
A4A1R3	0757-0424	9		RESISTOR 1.1K 1% .125W F TC0+-100	24546	C4-1/8-T0-1101-F	
A4A1R4	0698-3445	2		RESISTOR 348 1% .125W F TC0+-100	24546	C4-1/8-T0-348R-F	
A4A1R5	0698-0083	8		RESISTOR 1.96K 1% .125W F TC0+-100	24546	C4-1/8-T0-1961-F	
A4A1R6	0698-0083	8	2	RESISTOR 1.96K 1% .125W F TC0+-100	24546	C4-1/8-T0-1961-F	
A4A1R7*	0757-0403	3		RESISTOR 121 1% .125W F TC0+-100	24546	C4-1/8-T0-121R-F	
A4A1R8	0757-0280	2		RESISTOR 1K 1% .125W F TC0+-100	24546	C4-1/8-T0-1001-F	
A4A1R9	0757-0394	0		RESISTOR 51.1 1% .125W F TC0+-100	24546	C4-1/8-T0-511R-F	
A4A1R10	0698-3444	1		RESISTOR 316 1% .125W F TC0+-100	24546	C4-1/8-T0-316R-F	
A4A1R11	0757-0419	0	0	RESISTOR 681 1% .125W F TC0+-100	24546	C4-1/8-T0-681R-F	
A4A1R12	0698-3445	2		RESISTOR 348 1% .125W F TC0+-100	24546	C4-1/8-T0-348R-F	
A4A1R13	0698-0083	8		RESISTOR 1.96K 1% .125W F TC0+-100	24546	C4-1/8-T0-1961-F	
A4A1R14	0698-0083	8		RESISTOR 1.96K 1% .125W F TC0+-100	24546	C4-1/8-T0-1961-F	
A4A1R15	0698-0082	7		RESISTOR 464 1% .125W F TC0+-100	24546	C4-1/8-T0-4640-F	
A4A1R16	0698-3378	0	1	RESISTOR 51 5% .125W CC TCR=270/+540	01121	885105	
A4A1R17	0698-3435	0		RESISTOR 383 1% .125W F TC0+-100	24546	C4-1/8-T0-383R-F	
A4A1R18	0698-3446	3		RESISTOR 383 1% .125W F TC0+-100	24546	C4-1/8-T0-383R-F	
A4A1R19	0757-0401	0		RESISTOR 100 1% .125W F TC0+-100	24546	C4-1/8-T0-101-F	
A4A1R20	0758-0003	0		RESISTOR 1K 5% .25W F TC0+-100	24546	C5-1/4-T0-1001-J	
A4A1R21	0757-0280	3	3	RESISTOR 1K 1% .125W F TC0+-100	24546	C4-1/8-T0-1001-F	
A4A1R22	0698-3442	9		RESISTOR 237 1% .125W F TC0+-100	24546	C4-1/8-T0-237R-F	
A4A1RFC1	9100-1788	6	5	CHOKE-WIDE BAND ZMAX=680 OHM@ 180 MHZ	02114	VK200 20/46	
A4A1RFC2	9100-1788	6		CHOKE-WIDE BAND ZMAX=680 OHM@ 180 MHZ	02114	VK200 20/46	
A4A1RFC3	9100-1788	6		CHOKE-WIDE BAND ZMAX=680 OHM@ 180 MHZ	02114	VK200 20/46	
A4A1Y1	0410-0199	9	1	CRYSTAL-QUARTZ 200.000 MHZ	28480	0410-0199	
A4A2	08698-6029	4	1	DBC. LOW PASS FILTER ASSEMBLY	28480	08698-6029	
A4A2	08698-0005	8	1	CAN-FILTER	28480	08698-0005	
A4A2	08698-0008	4	1	COVER-CAN	28480	08698-0008	

See introduction to this section for ordering information
 *Indicates factory selected value

Table 6-2. REPLACEABLE PARTS

Reference Designation	HP Part Number	C D	Qty	Description	Mfr Code	Mfr Part Number
A4A2J1	1250-0826	0	1	CONNECTOR-RF SMC M 8GL-HOLE-RR 50-OHM	28480	1250-0826
A4A2A1	08698-6009	2	1	OBC. & LOW PASS FILTER BOARD ASSEMBLY	28480	08698-6009
A4A2A1C1	0140-0190	7	2	CAPACITOR-FXD 36PF +-5% 300VDC MICA	72136	DM15E90J0300HV1CR
A4A2A1C2	0140-0191	8		CAPACITOR-FXD 56PF +-5% 300VDC MICA	72136	DM15E96J0300HV1CR
A4A2A1C3	0160-2201	7		CAPACITOR-FXD 51PF +-5% 300VDC MICA	28480	0160-2201
A4A2A1C4	0140-0191	8		CAPACITOR-FXD 56PF +-5% 300VDC MICA	72136	DM15E96J0300HV1CR
A4A2A1C5	0140-0190	7		CAPACITOR-FXD 36PF +-5% 300VDC MICA	72136	DM15E90J0300HV1CR
A4A2A1L1				NBR,PART OF BD. ASSY-TYPICAL VALUE 60NH		
A4A2A1L2				NBR,PART OF BD. ASSY-TYPICAL VALUE 60NH		
A4A2A1L3				NBR,PART OF BD. ASSY-TYPICAL VALUE 60NH		
A4A2A1L4				NBR,PART OF BD. ASSY-TYPICAL VALUE 60NH		
A4A3A1	08601-6041	5		MIXER ASSEMBLY	28480	08601-6041
A4A3A1	08698-0007	2		BOX-MIXER	28480	08698-0007
A4A3A1	08698-0009	6		PLATE-INSULATOR	28480	08698-0009
A4A3A1C1	0160-2264	2		CAPACITOR-FXD 20PF +-5% 500VDC CER 0+-30	28480	0160-2264
A4A3A1C2	0150-0021	4		CAPACITOR-FXD .47PF +-5% 500VDC T1 D10X	28480	0150-0021
A4A3A1C3	0150-0021	4		CAPACITOR-FXD .47PF +-5% 500VDC T1 D10X	28480	0150-0021
A4A3A1C4	0160-1743	2		CAPACITOR-FXD .1UF+-10% 35VDC TA	56289	150D104X4035A2
A4A3A1C5	0160-0301	4		CAPACITOR-FXD .012UF +-10% 200VDC POLYE	28480	0160-0301
A4A3A1CR1	1901-0557	5		DIODE-ARRAY VF DIFF=5MV	28480	1901-0557
A4A3A1L1	9100-0368	6		COIL-MLD 330NH 10% Q#28 .095DX,25LG-NOM	28480	9100-0368
A4A3A1L2	9100-0368	6		COIL-MLD 330NH 10% Q#28 .095DX,25LG-NOM	28480	9100-0368
A4A3A1L3	08698-6013	1		COIL-VAR	28480	08698-6013
A4A3A1L4	9140-0094	9		COIL-MLD 660NH 10% Q#50 .155DX,375LG-NOM	28480	9140-0094
A4A3A1L5	9100-2247	4		COIL-MLD 100NH 10% Q#34 .095DX,25LG-NOM	28480	9100-2247
A4A3A1R1				NOT ASSIGNED		
A4A3A1R2	0698-3441	8		RESISTOR 215 1% .125W F TC=0+-100	24546	C4=1/8-WT=215R-F
A4A3A1T1	08698-6012	9		TRANSFORMER-MIXER	28480	08698-6012
A5	08601-6005	9	1	Oscillator Assembly-VOLTAGE TUNED	28480	08601-6005
A5				(INCL C1-C4,J1-J4, ASA1 ASSY & COVER)		
A5	08601-2031	0	1	FRONT PANEL-VTO ASSEMBLY	28480	08601-2031
A5	08601-2057	4	1	BOX-VTO	28480	08601-2057
A5C1	0160-2049	1		CAPACITOR-FDTHRU 5000PF +80 -20% 500V	33095	54-743-009-X5V0-502Z
A5C2	0160-2049	1		CAPACITOR-FDTHRU 5000PF +80 -20% 500V	33095	54-743-009-X5V0-502Z
A5C3	0160-2049	1		CAPACITOR-FDTHRU 5000PF +80 -20% 500V	33095	54-743-009-X5V0-502Z
A5C4	0160-2049	1		CAPACITOR-FDTHRU 5000PF +80 -20% 500V	33095	54-743-009-X5V0-502Z
A5J1	1250-0829	3		CONNECTOR-RF SMC M 8GL-HOLE-FR 50-OHM	28480	1250-0829
A5J2	1250-0829	3		CONNECTOR-RF SMC M 8GL-HOLE-FR 50-OHM	28480	1250-0829
A5J3	1250-0829	3		CONNECTOR-RF SMC M 8GL-HOLE-FR 50-OHM	28480	1250-0829
A5J4	1250-0829	3		CONNECTOR-RF SMC M 8GL-HOLE-FR 50-OHM	28480	1250-0829
ASA1	08601-6044	1	1	BOARD ASSEMBLY-VTO	28480	08601-6044
ASA1C1	0160-0194	3	1	CAPACITOR-FXD .015UF +-10% 200VDC POLYE	28480	0160-0194
ASA1C2	0140-0069	9	1	CAPACITOR-FDTHRU 550PF 10% 500V MICA	72982	666-034-01A4-851K
ASA1C3	0160-2140	3	2	CAPACITOR-FXD 470PF +80-20% 1KVDC CER	28480	0160-2140
ASA1C4	0160-2140	3		CAPACITOR-FXD 470PF +80-20% 1KVDC CER	28480	0160-2140
ASA1C5	0160-2266	4		CAPACITOR-FXD 24PF +-5% 500VDC CER 0+-30	28480	0160-2266
ASA1C6	0160-2139	0		CAPACITOR-FXD 220PF +80-20% 1KVDC CER	28480	0160-2139
ASA1C7	0160-2257	3		CAPACITOR-FXD 10PF +-5% 500VDC CER 0+-60	28480	0160-2257
ASA1C8	0150-0050	9		CAPACITOR-FXD 1000PF +80-20% 1KVDC CER	28480	0150-0050
ASA1C9	0160-2266	4		CAPACITOR-FXD 24PF +-5% 500VDC CER 0+-30	28480	0160-2266
ASA1C10	0160-2266	4		CAPACITOR-FXD 24PF +-5% 500VDC CER 0+-30	28480	0160-2266
ASA1C11	0160-2266	4		CAPACITOR-FXD 24PF +-5% 500VDC CER 0+-30	28480	0160-2266
ASA1C12	0150-0050	9		CAPACITOR-FXD 1000PF +80-20% 1KVDC CER	28480	0150-0050
ASA1C13	0160-2266	4		CAPACITOR-FXD 24PF +-5% 500VDC CER 0+-30	28480	0160-2266
ASA1C14	0160-2266	4		CAPACITOR-FXD 24PF +-5% 500VDC CER 0+-30	28480	0160-2266
ASA1C15	0160-2257	3		CAPACITOR-FXD 10PF +-5% 500VDC CER 0+-60	28480	0160-2257
ASA1C16	0160-2266	4		CAPACITOR-FXD 24PF +-5% 500VDC CER 0+-30	28480	0160-2266
ASA1C17	0160-2266	4		CAPACITOR-FXD 24PF +-5% 500VDC CER 0+-30	28480	0160-2266
ASA1C18	0150-0050	9		CAPACITOR-FXD 1000PF +80-20% 1KVDC CER	28480	0150-0050
ASA1C19	0160-2266	4		CAPACITOR-FXD 24PF +-5% 500VDC CER 0+-30	28480	0160-2266
ASA1C20	0160-2257	3		CAPACITOR-FXD 10PF +-5% 500VDC CER 0+-60	28480	0160-2257
ASA1C21	0160-0291	3		CAPACITOR-FXD 1UF+-10% 35VDC TA	56289	150D104X4035A2
ASA1C22	0160-0197	6		CAPACITOR-FXD 2.2UF+-10% 20VDC TA	56289	150D225X9020A2
ASA1C23	0150-0050	9		CAPACITOR-FXD 1000PF +80-20% 1KVDC CER	28480	0150-0050
ASA1C24	0150-0050	9		CAPACITOR-FXD 1000PF +80-20% 1KVDC CER	28480	0150-0050
ASA1C25	0150-0050	9		CAPACITOR-FXD 1000PF +80-20% 1KVDC CER	28480	0150-0050
ASA1C26	0150-0050	9		CAPACITOR-FXD 1000PF +80-20% 1KVDC CER	28480	0150-0050
ASA1C27	0150-0050	9		CAPACITOR-FXD 1000PF +80-20% 1KVDC CER	28480	0150-0050
ASA1C28	0150-0050	9		CAPACITOR-FXD 1000PF +80-20% 1KVDC CER	28480	0150-0050
ASA1C29	0150-0050	9		CAPACITOR-FXD 1000PF +80-20% 1KVDC CER	28480	0150-0050
ASA1C30	0150-0050	9		CAPACITOR-FXD 1000PF +80-20% 1KVDC CER	28480	0150-0050

See introduction to this section for ordering information
 *Indicates factory selected value

Table 6-2. REPLACEABLE PARTS

Reference Designation	HP Part Number	C D	Qty	Description	Mfr Code	Mfr Part Number
ASA1C31	0150-0050	9		CAPACITOR-FXD 1000PF +80-20% 1KVDC CER	28480	0150-0050
ASA1CR1	1901-0033	2		DIODE-GEN PRP 180V 200MA DO-7	28480	1901-0033
ASA1CR2	1901-0033	2		DIODE-GEN PRP 180V 200MA DO-7	28480	1901-0033
ASA1CR3	1901-0033	2		DIODE-GEN PRP 180V 200MA DO-7	28480	1901-0033
ASA1CR4	1901-0033	2		DIODE-GEN PRP 180V 200MA DO-7	28480	1901-0033
ASA1CR5	0122-0274	0	1	DIODE-VVC 18PF 5K C4/C60-MIN=2.6 BVR=60V	28480	0122-0274
ASA1K1	0490-0399	9		RELAY-REED 1A 100MA 12VDC-COIL 3VA	28480	0490-0399
ASA1L1	08553-6015	1	1	INDUCTOR-FXD (CW) GREEN	28480	08553-6015
ASA1L2	08553-6016	3	1	INDUCTOR-FXD (CCW) BLUE	28480	08553-6016
ASA1L3	9100-1610	3		COIL-MLD 150NH 20% Q#50 .155DX,375LG-NOM	28480	9100-1610
ASA1L4	9140-0094	9		COIL-MLD 680NH 10% Q#50 .155DX,375LG-NOM	28480	9140-0094
ASA1L5	9100-1610	3		COIL-MLD 150NH 20% Q#50 .155DX,375LG-NOM	28480	9100-1610
ASA1L6	9100-1610	3		COIL-MLD 150NH 20% Q#50 .155DX,375LG-NOM	28480	9100-1610
ASA1L7	9100-1610	3		COIL-MLD 150NH 20% Q#50 .155DX,375LG-NOM	28480	9100-1610
ASA1L8	9100-1610	3		COIL-MLD 150NH 20% Q#50 .155DX,375LG-NOM	28480	9100-1610
ASA1Q1	1854-0580	3	2	TRANSISTOR NPN SI TO-39 PD#3.5W	04713	MM6001
ASA1Q2	1854-0345	8		TRANSISTOR NPN 2N5179 SI TO-72 PD#200MW	04713	2N5179
ASA1Q3	1854-0580	3		TRANSISTOR NPN SI TO-39 PD#3.5W	04713	MM6001
ASA1Q4	1854-0345	6		TRANSISTOR NPN 2N5179 SI TO-72 PD#200MW	04713	2N5179
ASA1Q5	1854-0021	7	1	TRANSISTOR NPN 2N918 SI TO-72 PD#200MW	07263	2N918
ASA1Q6	1854-0345	6		TRANSISTOR NPN 2N5179 SI TO-72 PD#200MW	04713	2N5179
ASA1Q7	1854-0345	6		TRANSISTOR NPN 2N5179 SI TO-72 PD#200MW	04713	2N5179
ASA1Q8	1854-0071	7		TRANSISTOR NPN SI PD#300MW FT#200MHZ	28480	1854-0071
ASA1Q9	1854-0022	8	2	TRANSISTOR NPN SI TO-39 PD#700MW	07263	817843
ASA1R1	0698-3159	5	8	RESISTOR 26.1K 1% .125W F TC#0+-100	24546	C4=1/8-T0=2612-F
ASA1R2	0757-0439	4		RESISTOR 6.81K 1% .125W F TC#0+-100	24546	C4=1/8-T0=6811-F
ASA1R3	0698-3150	6	4	RESISTOR 2.37K 1% .125W F TC#0+-100	24546	C4=1/8-T0=2371-F
ASA1R4	0757-0280	3		RESISTOR 1K 1% .125W F TC#0+-100	24546	C4=1/8-T0=1001-F
ASA1R5	0757-0428	1		RESISTOR 1.62K 1% .125W F TC#0+-100	24546	C4=1/8-T0=1621-F
ASA1R6	0698-3150	6		RESISTOR 2.37K 1% .125W F TC#0+-100	24546	C4=1/8-T0=2371-F
ASA1R7	0757-0837	6	1	RESISTOR 8.25K 1% .5W F TC#0+-100	28480	0757-0837
ASA1R8	0698-3447	4	1	RESISTOR 422 1% .125W F TC#0+-100	24546	C4=1/8-T0=422R-F
ASA1R9	0757-0428	1		RESISTOR 1.62K 1% .125W F TC#0+-100	24546	C4=1/8-T0=1621-F
ASA1R10	0698-3158	4	6	RESISTOR 23.7K 1% .125W F TC#0+-100	24546	C4=1/8-T0=2372-F
ASA1R11	2100-2030	6	1	RESISTOR-TRMR 20K 10% C TOP-ADJ 1-TRN	73138	82PR20K
ASA1R12*	0698-3455	4	2	RESISTOR 261K 1% .125W F TC#0+-100	24546	C4=1/8-T0=2613-F
ASA1R13	2100-2655	1	1	RESISTOR-TRMR 100K 10% C TOP-ADJ 1-TRN	73138	82PR100K
ASA1R14	0698-3451	0	1	RESISTOR 133K 1% .125W F TC#0+-100	24546	C4=1/8-T0=1333-F
ASA1R15	0757-0441	8	4	RESISTOR 8.25K 1% .125W F TC#0+-100	24546	C4=1/8-T0=8251-F
ASA1R16	0757-0420	3		RESISTOR 750 1% .125W F TC#0+-100	24546	C4=1/8-T0=751-F
ASA1R17	0757-0199	3	4	RESISTOR 21.5K 1% .125W F TC#0+-100	24546	C4=1/8-T0=2152-F
ASA1R18	0757-0280	3		RESISTOR 1K 1% .125W F TC#0+-100	24546	C4=1/8-T0=1001-F
ASA1R19	0757-0280	3		RESISTOR 1K 1% .125W F TC#0+-100	24546	C4=1/8-T0=1001-F
ASA1R20	0757-0428	1		RESISTOR 1.62K 1% .125W F TC#0+-100	24546	C4=1/8-T0=1621-F
ASA1R21	0757-0416	7	5	RESISTOR 511 1% .125W F TC#0+-100	24546	C4=1/8-T0=511R-F
ASA1R22	0757-0317	7		RESISTOR 1.33K 1% .125W F TC#0+-100	24546	C4=1/8-T0=1331-F
ASA1R23	0757-0421	4		RESISTOR 825 1% .125W F TC#0+-100	24546	C4=1/8-T0=825R-F
ASA1R24	0698-3152	8	2	RESISTOR 3.48K 1% .125W F TC#0+-100	24546	C4=1/8-T0=3481-F
ASA1R25	0698-3446	3		RESISTOR 383 1% .125W F TC#0+-100	24546	C4=1/8-T0=383R-F
ASA1R26	0757-0819	4	1	RESISTOR 909 1% .5W F TC#0+-100	28480	0757-0819
ASA1R27	0757-0401	0		RESISTOR 100 1% .125W F TC#0+-100	24546	C4=1/8-T0=101-F
ASA1R28	0757-0280	3		RESISTOR 1K 1% .125W F TC#0+-100	24546	C4=1/8-T0=1001-F
ASA1R29	0757-0417	8	3	RESISTOR 562 1% .125W F TC#0+-100	24546	C4=1/8-T0=562R-F
ASA1R30	0757-0401	0		RESISTOR 100 1% .125W F TC#0+-100	24546	C4=1/8-T0=101-F
ASA1R31	0698-0090	7	2	RESISTOR 464 1% .5W F TC#0+-100	28480	0698-0090
ASA1R32	0757-1060	9	2	RESISTOR 196 1% .5W F TC#0+-100	28480	0757-1060
ASA1R33	0698-3440	0		RESISTOR 196 1% .125W F TC#0+-100	24546	C4=1/8-T0=196R-F
ASA1R34	0757-0401	7		RESISTOR 100 1% .125W F TC#0+-100	24546	C4=1/8-T0=101-F
ASA1R35	0757-0401	0		RESISTOR 100 1% .125W F TC#0+-100	24546	C4=1/8-T0=101-F
ASA1R36	0757-0280	3		RESISTOR 1K 1% .125W F TC#0+-100	24546	C4=1/8-T0=1001-F
ASA1R37	0757-0417	8		RESISTOR 562 1% .125W F TC#0+-100	24546	C4=1/8-T0=562R-F
ASA1R38	0757-0401	7		RESISTOR 100 1% .125W F TC#0+-100	24546	C4=1/8-T0=101-F
ASA1R39	0698-0090	0		RESISTOR 464 1% .5W F TC#0+-100	28480	0698-0090
ASA1R40	0757-1060	9		RESISTOR 196 1% .5W F TC#0+-100	28480	0757-1060
ASA1RFC1	9100-1788	6		CHOKE-WIDE BAND ZMAX#680 OHM@ 180 MHZ	02114	VK200 20/48
ASA1RFC2	9100-1788	6		CHOKE-WIDE BAND ZMAX#680 OHM@ 180 MHZ	02114	VK200 20/48
ASA1RFC3	9170-0807	3	2	CORE-SHIELDING BEAD	02114	56-990-65/38 PARYLENE COATED
ASA1RFC4	9170-0807	3		CORE-SHIELDING BEAD	02114	56-990-65/38 PARYLENE COATED
A6	08601-6006	1	1	AMPLIFIER ASSEMBLY-VIDEO (DOES NOT INCLUDE A6A1E1 & A6A1E2) (INCL C1=2, J1=2, A6A1 ASSY & COVER)	28480	08601-6006
A6	08601-0007	7	1	COVER-VIDEO AMPLIFIER	28480	08601-0007
A6	08601-2010	6	1	HOUSING-VIDEO AMPLIFIER	28480	08601-2010

See introduction to this section for ordering information
*Indicates factory selected value

Table 6-2. REPLACEABLE PARTS

Reference Designation	HP Part Number	C D	Qty	Description	Mfr Code	Mfr Part Number
A6C1	0160-2049	1		CAPACITOR-FDTHRU 5000PF +80 -20% 500V	33095	54-743-009-X5V0-502Z
A6C2	0160-2049	1		CAPACITOR-FDTHRU 5000PF +80 -20% 500V	33095	54-743-009-X5V0-502Z
A6J1	1250-0829	3		CONNECTOR-RF SMC M 8GL-HOLE-FR 50-OHM	28480	1250-0829
A6J2	1250-0829	3		CONNECTOR-RF SMC M 8GL-HOLE-FR 50-OHM	28480	1250-0829
A6A1	08601-6026	3	1	BOARD ASSEMBLY-VIDED AMPLIFIER	28480	08601-6026
A6A1C1	0180-0097	7	4	CAPACITOR-FXD .47UF+/-10% 35VDC TA	56289	150D474X9035A2
A6A1C2	0180-0376	5	3	CAPACITOR-FXD .47UF+/-10% 35VDC TA	56289	150D474X9035A2
A6A1C3	0180-0097	7		CAPACITOR-FXD .47UF+/-10% 35VDC TA	56289	150D474X9035A2
A6A1C4	0160-3060	8	2	CAPACITOR-FXD .1UF +/-20% 25VDC CER	28480	0160-3060
A6A1C5	0160-3060	8		CAPACITOR-FXD .1UF +/-20% 25VDC CER	28480	0160-3060
A6A1C6				NOT ASSIGNED		
A6A1C7	0180-0376	5		CAPACITOR-FXD .47UF+/-10% 35VDC TA	56289	150D474X9035A2
A6A1C8	0180-0376	5		CAPACITOR-FXD .47UF+/-10% 35VDC TA	56289	150D474X9035A2
A6A1E1	5086-7010	3		INTEGRATED CIRCUIT	28480	5086-7010
A6A1E2	5086-7112	6	1	INTEGRATED CIRCUIT	28480	5086-7112
A6A1L1	9140-0142	8	2	COIL-MLD 2.2UH 10% Q#32 .095DX.25LG-NOM	28480	9140-0142
A6A1L2	9140-0142	8		COIL-MLD 2.2UH 10% Q#32 .095DX.25LG-NOM	28480	9140-0142
A6A1MP1	1251-1556	7	15	CONNECTOR-SGL CONT SKT .018-IN-B8C-82	28480	1251-1556
A6A1MP2	1251-1556	7		CONNECTOR-SGL CONT SKT .018-IN-B8C-82	28480	1251-1556
A6A1MP3	1251-1556	7		CONNECTOR-SGL CONT SKT .018-IN-B8C-82	28480	1251-1556
A6A1MP4	1251-1556	7		CONNECTOR-SGL CONT SKT .018-IN-B8C-82	28480	1251-1556
A6A1MP5	1251-1556	7		CONNECTOR-SGL CONT SKT .018-IN-B8C-82	28480	1251-1556
A6A1MP6	1251-1556	7		CONNECTOR-SGL CONT SKT .018-IN-B8C-82	28480	1251-1556
A6A1MP7	1251-1556	7		CONNECTOR-SGL CONT SKT .018-IN-B8C-82	28480	1251-1556
A6A1MP8	1251-1556	7		CONNECTOR-SGL CONT SKT .018-IN-B8C-82	28480	1251-1556
A6A1MP9	1251-1556	7		CONNECTOR-SGL CONT SKT .018-IN-B8C-82	28480	1251-1556
A6A1MP10	1251-1556	7		CONNECTOR-SGL CONT SKT .018-IN-B8C-82	28480	1251-1556
A6A1MP11	1251-1556	7		CONNECTOR-SGL CONT SKT .018-IN-B8C-82	28480	1251-1556
A6A1MP12	1251-1556	7		CONNECTOR-SGL CONT SKT .018-IN-B8C-82	28480	1251-1556
A6A1MP13	1251-1556	7		CONNECTOR-SGL CONT SKT .018-IN-B8C-82	28480	1251-1556
A6A1MP14	1251-1556	7		CONNECTOR-SGL CONT SKT .018-IN-B8C-82	28480	1251-1556
A6A1MP15	1251-1556	7		CONNECTOR-SGL CONT SKT .018-IN-B8C-82	28480	1251-1556
A6A1R1	0757-0346	2		RESISTOR 10 1% .125W F TC00+/-100	24546	C4=1/8-T0=10R0-F
A6A1R2	0757-0346	2		RESISTOR 10 1% .125W F TC00+/-100	24546	C4=1/8-T0=10R0-F
A6A1R3	0757-0346	2		RESISTOR 10 1% .125W F TC00+/-100	24546	C4=1/8-T0=10R0-F
A6A1R4	0698-3352	8		RESISTOR 3.48K 1% .125W F TC00+/-100	24546	C4=1/8-T0=3481-F
A6A1R5	0757-0444	1	3	RESISTOR 12.1K 1% .125W F TC00+/-100	24546	C4=1/8-T0=1212-F
A6A1R6*	0698-3380	4	1	RESISTOR 75 5% .125W CC TC=270/+340	01121	BB7505
A7	08601-6007	3	1	ATTENUATOR ASSEMBLY	28480	08601-6007
A7	08601-6057	8	1	ATTENUATOR ASSEMBLY (OPT 008, 009, 010 ONLY)	28480	08601-6057
A7J1	1250-0829	3		CONNECTOR-RF SMC M 8GL-HOLE-FR 50-OHM	28480	1250-0829
A7MP1	08601-2001	7	1	HOUSING-ATTENUATOR ASSEMBLY	28480	08601-2001
A7R1	0727-0028	4	4	RESISTOR 53.27 .5% .25W CF TC00-500	28480	0727-0028
A7R2	0727-0091	1	3	RESISTOR 790 .5% .25W CF TC00-500	28480	0727-0091
A7R3	0727-0028	4		RESISTOR 53.27 .5% .25W CF TC00-500	28480	0727-0028
A7R4	0727-0034	2	2	RESISTOR 61.11 .5% .25W CF TC00-500	28480	0727-0034
A7R5	0727-0062	6	1	RESISTOR 247.5 .5% .25W CF TC00-500	28480	0727-0062
A7R6	0727-0034	2		RESISTOR 61.11 .5% .25W CF TC00-500	28480	0727-0034
A7R7	0727-0042	2	2	RESISTOR 96.25 .5% .25W CF TC00-500	28480	0727-0042
A7R8	0727-0037	5	1	RESISTOR 71.19 .5% .25W CF TC00-500	28480	0727-0037
A7R9	0727-0042	2		RESISTOR 96.25 .5% .25W CF TC00-500	28480	0727-0042
A7R10	0727-0028	4		RESISTOR 53.27 .5% .25W CF TC00-500	28480	0727-0028
A7R11	0727-0091	1		RESISTOR 790 .5% .25W CF TC00-500	28480	0727-0091
A7R12	0727-0016	0	1	RESISTOR 26.63 .5% .5W CF TC00-500	28480	0727-0016
A7R13	0727-0091	1		RESISTOR 790 .5% .25W CF TC00-500	28480	0727-0091
A7R14	0727-0028	4		RESISTOR 53.27 .5% .25W CF TC00-500	28480	0727-0028
A7R15	0683-2405	1	1	RESISTOR 24 5% .25W FC TC=400/+500 (OPT 008, 009, 010 ONLY)	01121	CB2405
A7S1	3102-0006	7	4	SWITCH=8ENS SPDT SUBMIN 1A 30VDC	28480	3102-0006
A7S2	3102-0006	7		SWITCH=8ENS SPDT SUBMIN 1A 30VDC	28480	3102-0006
A7S3	3102-0006	7		SWITCH=8ENS SPDT SUBMIN 1A 30VDC	28480	3102-0006
A7S4	3102-0006	7		SWITCH=8ENS SPDT SUBMIN 1A 30VDC	28480	3102-0006
	08601-00052	1	1	DIAL=KNOB ASSEMBLY-ATTENUATOR	28480	08601-00052
A8	08601-6018	6	1	BOARD ASSEMBLY-RECTIFIER	28480	08601-6018
A8C1	0150-0082	7	2	CAPACITOR-FXD 8200PF500VDC CER	28480	0150-0082
A8C2	0150-0082	7		CAPACITOR-FXD 8200PF500VDC CER	28480	0150-0082

See introduction to this section for ordering information
*Indicates factory selected value

Table 6-2. REPLACEABLE PARTS

Reference Designation	HP Part Number	C D	Qty	Description	Mfr Code	Mfr Part Number
A8CR1	1901-0418	7	2	DIODE=PWR RECT 400V 1.5A	28480	1901-0418
A8CR2	1901-0418	7		DIODE=PWR RECT 400V 1.5A	28480	1901-0418
A8CR3	1901-0028	5	2	DIODE=PWR RECT 400V 750MA DO=29	28480	1901-0028
A8CR4	1901-0028	5		DIODE=PWR RECT 400V 750MA DO=29	28480	1901-0028
A8F1	2110-0055	2	1	FUSE 4A 250V 1.25X.25 UL	75915	312004
A8F2	2110-0064	3	1	FUSE .125A 250V 1.25X.25 UL	28480	2110-0064
A9	08601-6019	8	1	BOARD ASSEMBLY=FREQ CONTROL & LEVELING NOTE: TO OBTAIN AN A9 FREQUENCY CONTROL AND LEVELING BOARD FOR OPTIONS 001, 002, 003, 005, 006, 011, 012 ORDER BOARD REPLACEMENT KIT HP PART NO. 08601-00112. TABLE 6-1 SHOWS THE COMPONENT CHANGES NEEDED FOR CONVERTING THE STANDARD A9 BOARD TO EACH OPTION.	28480	08601-6019
A9C1	0180-0231	1	1	CAPACITOR=FXD 3.5UF±20% 75VDC TA	06001	69F18557
A9C2	0180-2186	9	1	CAPACITOR=FXD 300UF±20% 30VDC TA	06001	69F45507
A9C3	0170-0040	9	1	CAPACITOR=FXD .047UF ±10% 200VDC POLYE	56289	292P47392
A9C4	0160-2214	2	1	CAPACITOR=FXD 680PF ±5% 300VDC MICA	28480	0160-2214
A9C5	0160-2225	5	2	CAPACITOR=FXD 2000PF ±5% 300VDC MICA	28480	0160-2225
A9C6	0180-0229	7	1	CAPACITOR=FXD 33UF±10% 10VDC TA	56289	150D33X9010B2
A9C7	0180-1746	5	2	CAPACITOR=FXD 15UF±10% 20VDC TA	56289	150D15X9020B2
A9C8	0180-1746	5		CAPACITOR=FXD 15UF±10% 20VDC TA	56289	150D15X9020B2
A9C9	0180-0050	2	1	CAPACITOR=FXD 40UF±75% 10X 50VDC AL	56289	30D406050D02
A9C10	0160-4297	5	2	CAPACITOR=FXD .022UF ±80% 20X 100VDC CER	56289	C023F101H223Z822=CDM
A9C11	0170-0083	0	1	CAPACITOR=FXD .022UF ±20% 50VDC POLYE	84411	601PE2230R5W1
A9C12	0180-0197	8	1	CAPACITOR=FXD 2.2UF±10% 20VDC TA	56289	150D22X9020A2
A9C13	0160-0153	4	1	CAPACITOR=FXD 1000PF ±10% 200VDC POLYE	28480	0160-0153
A9C14	0160-0174	9	1	CAPACITOR=FXD .47UF ±80% 20X 25VDC CER	28480	0160-0174
A9C15	0180-1743	2	1	CAPACITOR=FXD .1UF±10% 35VDC TA	56289	150D104X9035A2
A9C16	0180-1743	2		CAPACITOR=FXD .1UF±10% 35VDC TA	56289	150D104X9035A2
A9C17	0180-1747	6	1	CAPACITOR=FXD 150UF±20% 15VDC TA	56289	150D157X0015
A9C18	0160-2055	9	1	CAPACITOR=FXD .01UF ±80% 20X 100VDC CER	28480	0160-2055
A9C19	0160-0298	8	1	CAPACITOR=FXD 1500PF ±10% 200VDC POLYE	28480	0160-0298
A9C20	0180-0291	3	1	CAPACITOR=FXD 1UF±10% 35VDC TA	56289	150D105X9035A2
A9C21-				NOT ASSIGNED		
A9C23						
A9C24	0180-0291	3		CAPACITOR=FXD 1UF±10% 35VDC TA	56289	150D105X9035A2
A9C25	0160-2225	5		CAPACITOR=FXD 2000PF ±5% 300VDC MICA	28480	0160-2225
A9C26	0160-2229	9	1	CAPACITOR=FXD 3000PF ±5% 300VDC MICA	28480	0160-2229
A9C27	0180-0228	6	1	CAPACITOR=FXD 22UF±10% 15VDC TA	56289	150D22X9015B2
A9C28	0160-0161	4	1	CAPACITOR=FXD .01UF ±10% 200VDC POLYE	28480	0160-0161
A9C29	0180-1731	8	1	CAPACITOR=FXD 4.7UF±10% 50VDC TA	56289	150D475X9050B2
A9C30	0180-1735	2	1	CAPACITOR=FXD .22UF±10% 35VDC TA	56289	150D22X9035A2
A9C31	0140-0184	9	2	CAPACITOR=FXD 8200PF ±1X 100VDC MICA	72136	DM20F822P0100HV1CR
A9C31	0140-0166	7	1	CAPACITOR=FXD .017UF ±2X 300VDC MICA (OPT 005 ONLY)	72136	DM30F17300300HV1CR
A9C32	0160-2228	8	2	CAPACITOR=FXD 2700PF ±5% 300VDC MICA	28480	0160-2228
A9C32	0140-0184	9		CAPACITOR=FXD 8200PF ±1X 100VDC MICA (OPT 005 ONLY)	72136	DM20F822P0100HV1CR
A9C33	0160-3539	6	1	CAPACITOR=FXD 820PF ±5% 100VDC MICA	28480	0160-3539
A9C33	0160-2228	8		CAPACITOR=FXD 2700PF ±5% 300VDC MICA (OPT 005 ONLY)	28480	0160-2228
A9C34	0180-0197	8		CAPACITOR=FXD 2.2UF±10% 20VDC TA	56289	150D22X9020A2
A9C35	0160-0163	6	1	CAPACITOR=FXD .033UF ±10% 200VDC POLYE	28480	0160-0163
A9C35	0160-0168	1	1	CAPACITOR=FXD .1UF ±10% 200VDC POLYE (OPT 005 ONLY)	28480	0160-0168
A9C36	0160-4297	5		CAPACITOR=FXD .022UF ±80% 20X 100VDC CER	56289	C023F101H223Z822=CDM
A9C37	0180-0291	3		CAPACITOR=FXD 1UF±10% 35VDC TA	56289	150D105X9035A2
A9C37	0180-0197	8		CAPACITOR=FXD 2.2UF±10% 20VDC TA (OPT 005 ONLY)	56289	150D22X9020A2
A9C38	0180-0197	8		CAPACITOR=FXD 2.2UF±10% 20VDC TA	56289	150D22X9020A2
A9C38	0180-0374	3		CAPACITOR=FXD 10UF±10% 20VDC TA (OPT 005 ONLY)	56289	150D106X9020B2
A9C39	0180-0159	2	1	CAPACITOR=FXD 220UF±20% 10VDC TA	56289	150D227X0010B2
A9C40	0180-0291	3		CAPACITOR=FXD 1UF±10% 35VDC TA	56289	150D105X9035A2
A9C41	0180-4300	1	1	CAPACITOR=FXD .047UF ±80% 20X 100VDC CER	56289	C023F101L473Z822=CDM
A9CR1	1901-0033	2		DIODE=GEN PRP 180V 200MA DO=7	28480	1901-0033
A9CR2	1901-0033	2		DIODE=GEN PRP 180V 200MA DO=7	28480	1901-0033
A9CR3	1902-3104	6	2	DIODE=ZNR 5.62V 5X DO=7 PDS .4H TC=+.016X	28480	1902-3104
A9CR4	1901-0033	2		DIODE=GEN PRP 180V 200MA DO=7	28480	1901-0033
A9CR5	1901-0033	2		DIODE=GEN PRP 180V 200MA DO=7	28480	1901-0033
A9CR6	1901-0033	2		DIODE=GEN PRP 180V 200MA DO=7	28480	1901-0033
A9CR7	1901-0033	2		DIODE=GEN PRP 180V 200MA DO=7	28480	1901-0033
A9CR8	1901-0033	2		DIODE=GEN PRP 180V 200MA DO=7	28480	1901-0033
A9CR9	1901-0033	2		DIODE=GEN PRP 180V 200MA DO=7	28480	1901-0033
A9CR10	1901-0033	2		DIODE=GEN PRP 180V 200MA DO=7	28480	1901-0033

See introduction to this section for ordering information
*Indicates factory selected value

Table 6-2. REPLACEABLE PARTS

Reference Designation	HP Part Number	C D	Qty	Description	Mfr Code	Mfr Part Number
A9CR11	1901-0033	2		DIODE-GEN PRP 180V 200MA DO-7	28480	1901-0033
A9CR12	1901-0033	2		DIODE-GEN PRP 180V 200MA DO-7	28480	1901-0033
A9CR13	1902-3104	6		DIODE-ZNR 5.62V 5% DO-7 PDR=.4W TC=+.01%K	28480	1902-3104
A9CR14	1901-0033	2		DIODE-GEN PRP 180V 200MA DO-7	28480	1901-0033
A9CR15	1901-0033	2		DIODE-GEN PRP 180V 200MA DO-7	28480	1901-0033
A9CR16				NOT ASSIGNED		
A9CR17	1901-0033	2		DIODE-GEN PRP 180V 200MA DO-7	28480	1901-0033
A9CR18	1901-0033	2		DIODE-GEN PRP 180V 200MA DO-7	28480	1901-0033
A9CR19	1901-0033	2		DIODE-GEN PRP 180V 200MA DO-7	28480	1901-0033
A9CR20	1902-0025	4	1	DIODE-ZNR 10V 5% DO-7 PDR=.4W TC=+.06%K	28480	1902-0025
A9CR21				NOT ASSIGNED		
A9CR22	1901-0033	2		DIODE-GEN PRP 180V 200MA DO-7	28480	1901-0033
A9CR23	1901-0033	2		DIODE-GEN PRP 180V 200MA DO-7	28480	1901-0033
A9CR24	1901-0033	2		DIODE-GEN PRP 180V 200MA DO-7	28480	1901-0033
A9CR25	1901-0033	2		DIODE-GEN PRP 180V 200MA DO-7	28480	1901-0033
A9CR26	1901-0033	2		DIODE-GEN PRP 180V 200MA DO-7	28480	1901-0033
A9CR27	1901-0033	2		DIODE-GEN PRP 180V 200MA DO-7	28480	1901-0033
A9CR28	1901-0033	2		DIODE-GEN PRP 180V 200MA DO-7	28480	1901-0033
A9CR29	1901-0033	2		DIODE-GEN PRP 180V 200MA DO-7	28480	1901-0033
A9CR30	1901-0033	2		DIODE-GEN PRP 180V 200MA DO-7	28480	1901-0033
A9CR31	1901-0033	2		DIODE-GEN PRP 180V 200MA DO-7	28480	1901-0033
A9E1	1826-0261	8	1	IC OP AMP LOW-NOISE TO-99	28480	1826-0261
A9L1				NOT ASSIGNED		
A9L2	9140-0131	5	1	COIL-MLD 10MH 5% GR60 .24DX.74LG-NOM	28480	9140-0131
A9L2	9100-2867	4	1	COIL-MLD 24MH 5% GR60 .30X.74LG-NOM (OPT 005 ONLY)	28480	9100-2867
A9Q1	1854-0221	9		TRANSISTOR-DUAL NPN PDR=750MH	28480	1854-0221
A9Q2	1853-0020	4		TRANSISTOR PNP SI PDR=300MH FT=150MHZ	28480	1853-0020
A9Q3	1853-0020	4		TRANSISTOR PNP SI PDR=300MH FT=150MHZ	28480	1853-0020
A9Q4	1853-0020	4		TRANSISTOR PNP SI PDR=300MH FT=150MHZ	28480	1853-0020
A9Q5	1853-0010	2	5	TRANSISTOR PNP SI TO-18 PDR=360MH	28480	1853-0010
A9Q6	1854-0071	7		TRANSISTOR NPN SI PDR=300MH FT=200MHZ	28480	1854-0071
A9Q7	1854-0071	7		TRANSISTOR NPN SI PDR=300MH FT=200MHZ	28480	1854-0071
A9Q8	1854-0071	7		TRANSISTOR NPN SI PDR=300MH FT=200MHZ	28480	1854-0071
A9Q9	1854-0071	7		TRANSISTOR NPN SI PDR=300MH FT=200MHZ	28480	1854-0071
A9Q10	1853-0020	4		TRANSISTOR PNP SI PDR=300MH FT=150MHZ	28480	1853-0020
A9Q11				NOT ASSIGNED		
A9Q12	1854-0221	9		TRANSISTOR-DUAL NPN PDR=750MH	28480	1854-0221
A9Q13	1854-0221	9		TRANSISTOR-DUAL NPN PDR=750MH	28480	1854-0221
A9Q14	1854-0071	7		TRANSISTOR NPN SI PDR=300MH FT=200MHZ	28480	1854-0071
A9Q15	1854-0071	7		TRANSISTOR NPN SI PDR=300MH FT=200MHZ	28480	1854-0071
A9Q16	1854-0071	7		TRANSISTOR NPN SI PDR=300MH FT=200MHZ	28480	1854-0071
A9Q17				NOT ASSIGNED		
A9Q18	1854-0295	7	1	TRANSISTOR-DUAL NPN PDR=400MH	28480	1854-0295
A9Q19	1854-0071	7		TRANSISTOR NPN SI PDR=300MH FT=200MHZ	28480	1854-0071
A9Q20	1854-0071	7		TRANSISTOR NPN SI PDR=300MH FT=200MHZ	28480	1854-0071
A9Q21	1854-0071	7		TRANSISTOR NPN SI PDR=300MH FT=200MHZ	28480	1854-0071
A9Q22	1854-0009	1		TRANSISTOR NPN SI PDR=300MH FT=600MHZ	04713	2N709
A9Q23	1854-0009	1		TRANSISTOR NPN SI PDR=300MH FT=600MHZ	04713	2N709
A9Q24	1854-0071	7		TRANSISTOR NPN SI PDR=300MH FT=200MHZ	28480	1854-0071
A9Q25	1854-0071	7		TRANSISTOR NPN SI PDR=300MH FT=200MHZ	28480	1854-0071
A9Q26	1853-0020	4		TRANSISTOR PNP SI PDR=300MH FT=150MHZ	28480	1853-0020
A9Q27	1854-0071	7		TRANSISTOR NPN SI PDR=300MH FT=200MHZ	28480	1854-0071
A9Q28	1854-0071	7		TRANSISTOR NPN SI PDR=300MH FT=200MHZ	28480	1854-0071
A9Q29	1854-0071	7		TRANSISTOR NPN SI PDR=300MH FT=200MHZ	28480	1854-0071
A9Q30	1853-0020	4		TRANSISTOR PNP SI PDR=300MH FT=150MHZ	28480	1853-0020
A9Q31	1853-0020	4		TRANSISTOR PNP SI PDR=300MH FT=150MHZ	28480	1853-0020
A9Q32	1854-0020	4		TRANSISTOR PNP SI PDR=300MH FT=150MHZ	28480	1854-0020
A9Q33	1854-0071	7		TRANSISTOR NPN SI PDR=300MH FT=200MHZ	28480	1854-0071
A9Q34	1854-0071	7		TRANSISTOR NPN SI PDR=300MH FT=200MHZ	28480	1854-0071
A9Q35	1854-0071	7		TRANSISTOR NPN SI PDR=300MH FT=200MHZ	28480	1854-0071
A9Q36	1854-0071	7		TRANSISTOR NPN SI PDR=300MH FT=200MHZ	28480	1854-0071
A9Q37	1853-0010	2		TRANSISTOR PNP SI TO-18 PDR=360MH	28480	1853-0010
A9Q38	1854-0071	7		TRANSISTOR NPN SI PDR=300MH FT=200MHZ	28480	1854-0071
A9Q39	1854-0071	7		TRANSISTOR NPN SI PDR=300MH FT=200MHZ	28480	1854-0071
A9Q40	1854-0071	7		TRANSISTOR NPN SI PDR=300MH FT=200MHZ	28480	1854-0071
A9Q41				NOT ASSIGNED		
A9Q42	1854-0071	7		TRANSISTOR NPN SI PDR=300MH FT=200MHZ	28480	1854-0071
A9R1	0757-0442	9		RESISTOR 10K 1% .125W F TC=0+-100	24546	C4-1/8-T0=1002-P
A9R2	0757-0438	3	4	RESISTOR 5.1K 1% .125W F TC=0+-100	24546	C4-1/8-T0=5111-P
A9R3	0757-0442	9		RESISTOR 10K 1% .125W F TC=0+-100	24546	C4-1/8-T0=1002-P
A9R4	0757-0458	7	5	RESISTOR 51.1K 1% .125W F TC=0+-100	24546	C4-1/8-T0=5112-P
A9R5	0757-0465	6		RESISTOR 100K 1% .125W F TC=0+-100	24546	C4-1/8-T0=1003-P

See introduction to this section for ordering information
 *Indicates factory selected value

Table 6-2. REPLACEABLE PARTS

Reference Designation	HP Part Number	C D	Qty	Description	Mfr Code	Mfr Part Number
A9R6	0757-0317	7		RESISTOR 1.33K 1% .125W F TC0+100	24546	C4-1/8-T0=1331-F
A9R7	0698-3158	4		RESISTOR 23.7K 1% .125W F TC0+100	24546	C4-1/8-T0=2372-F
A9R8	0757-0280	3		RESISTOR 1K 1% .125W F TC0+100	24546	C4-1/8-T0=1001-F
A9R9	0757-0444	1		RESISTOR 12.1K 1% .125W F TC0+100	24546	C4-1/8-T0=1212-F
A9R10	0757-0280	3		RESISTOR 1K 1% .125W F TC0+100	24546	C4-1/8-T0=1001-F
A9R11	0757-0440	7		RESISTOR 7.5K 1% .125W F TC0+100	24546	C4-1/8-T0=7501-F
A9R12	0757-0443	0	5	RESISTOR 11K 1% .125W F TC0+100	24546	C4-1/8-T0=1102-F
A9R13	0698-3158	4		RESISTOR 23.7K 1% .125W F TC0+100	24546	C4-1/8-T0=2372-F
A9R14	0757-0200	7	3	RESISTOR 5.62K 1% .125W F TC0+100	24546	C4-1/8-T0=5621-F
A9R15	0698-3454	3	4	RESISTOR 215K 1% .125W F TC0+100	24546	C4-1/8-T0=2153-F
A9R16	0757-0465	6		RESISTOR 100K 1% .125W F TC0+100	24546	C4-1/8-T0=1003-F
A9R17	0757-0280	3		RESISTOR 1K 1% .125W F TC0+100	24546	C4-1/8-T0=1001-F
A9R18	0698-3459	8		RESISTOR 383K 1% .125W F TC0+100	28480	0698-3459
A9R19	0698-3459	8		RESISTOR 383K 1% .125W F TC0+100	28480	0698-3459
A9R20	2100-3253	7		RESISTOR TRMR 50K 10% C TOP-ADJ 1-TRN	28480	2100-3253
A9R21	0698-3454	3		RESISTOR 215K 1% .125W F TC0+100	24546	C4-1/8-T0=2153-F
A9R22	0757-0465	6		RESISTOR 100K 1% .125W F TC0+100	24546	C4-1/8-T0=1003-F
A9R23	0757-0317	7		RESISTOR 1.33K 1% .125W F TC0+100	24546	C4-1/8-T0=1331-F
A9R24	2100-0554	5	1	RESISTOR TRMR 500 10% C TOP-ADJ 1-TRN	28480	2100-0554
A9R25	0698-3443	0		RESISTOR 287 1% .125W F TC0+100	24546	C4-1/8-T0=287R-F
A9R26	0698-3443	0		RESISTOR 287 1% .125W F TC0+100	24546	C4-1/8-T0=287R-F
A9R27	0757-0416	7		RESISTOR 511 1% .125W F TC0+100	24546	C4-1/8-T0=511R-F
A9R28	0698-3441	8		RESISTOR 215 1% .125W F TC0+100	24546	C4-1/8-T0=215R-F
A9R29	0698-3439	4	1	RESISTOR 178 1% .125W F TC0+100	24546	C4-1/8-T0=178R-F
A9R30	0757-0280	3		RESISTOR 1K 1% .125W F TC0+100	24546	C4-1/8-T0=1001-F
A9R31	0757-0442	9		RESISTOR 10K 1% .125W F TC0+100	24546	C4-1/8-T0=1002-F
A9R32	0698-3159	5		RESISTOR 26.1K 1% .125W F TC0+100	24546	C4-1/8-T0=2612-F
A9R33	0698-3452	1	1	RESISTOR 147K 1% .125W F TC0+100	24546	C4-1/8-T0=1473-F
A9R34	2100-3252	6	2	RESISTOR TRMR 5K 10% C TOP-ADJ 1-TRN	28480	2100-3252
A9R35	0698-3161	9	2	RESISTOR 36.3K 1% .125W F TC0+100	24546	C4-1/8-T0=3632-F
A9R36	0757-0280	3		RESISTOR 1K 1% .125W F TC0+100	24546	C4-1/8-T0=1001-F
A9R37	0698-0085	0	2	RESISTOR 2.61K 1% .125W F TC0+100	24546	C4-1/8-T0=2611-F
A9R38	0757-0460	1	1	RESISTOR 61.9K 1% .125W F TC0+100	24546	C4-1/8-T0=6192-F
A9R39	0757-0428	1		RESISTOR 1.62K 1% .125W F TC0+100	24546	C4-1/8-T0=1621-F
A9R40	0698-3162	0	2	RESISTOR 46.4K 1% .125W F TC0+100	24546	C4-1/8-T0=4642-F
A9R41	0757-0441	8		RESISTOR 8.25K 1% .125W F TC0+100	24546	C4-1/8-T0=8251-F
A9R42	0698-3449	6	5	RESISTOR 26.7K 1% .125W F TC0+100	24546	C4-1/8-T0=2672-F
A9R43				NOT ASSIGNED		
A9R44	0698-0082	7		RESISTOR 464 1% .125W F TC0+100	24546	C4-1/8-T0=4640-F
A9R45	0757-0442	9		RESISTOR 10K 1% .125W F TC0+100	24546	C4-1/8-T0=1002-F
A9R46	0757-0442	9		RESISTOR 10K 1% .125W F TC0+100	24546	C4-1/8-T0=1002-F
A9R47	0698-3455	4		RESISTOR 261K 1% .125W F TC0+100	24546	C4-1/8-T0=2613-F
A9R48	0757-0280	3		RESISTOR 1K 1% .125W F TC0+100	24546	C4-1/8-T0=1001-F
A9R49	0698-3260	9		RESISTOR 464K 1% .125W F TC0+100	28480	0698-3260
A9R50	0757-0280	3		RESISTOR 1K 1% .125W F TC0+100	24546	C4-1/8-T0=1001-F
A9R51	0698-3156	4		RESISTOR 23.7K 1% .125W F TC0+100	24546	C4-1/8-T0=2372-F
A9R52	0757-0279	0	3	RESISTOR 3.16K 1% .125W F TC0+100	24546	C4-1/8-T0=3161-F
A9R53	0757-0442	9		RESISTOR 10K 1% .125W F TC0+100	24546	C4-1/8-T0=1002-F
A9R54	0757-0465	6		RESISTOR 100K 1% .125W F TC0+100	24546	C4-1/8-T0=1003-F
A9R55	0757-0442	9		RESISTOR 10K 1% .125W F TC0+100	24546	C4-1/8-T0=1002-F
A9R56	0698-3159	5		RESISTOR 26.1K 1% .125W F TC0+100	24546	C4-1/8-T0=2612-F
A9R57	0698-3159	5		RESISTOR 26.1K 1% .125W F TC0+100	24546	C4-1/8-T0=2612-F
A9R58	0757-0465	6		RESISTOR 100K 1% .125W F TC0+100	24546	C4-1/8-T0=1003-F
A9R59	0698-3162	0		RESISTOR 46.4K 1% .125W F TC0+100	24546	C4-1/8-T0=4642-F
A9R60	0757-0443	0		RESISTOR 11K 1% .125W F TC0+100	24546	C4-1/8-T0=1102-F
A9R61	0698-3150	6		RESISTOR 2.37K 1% .125W F TC0+100	24546	C4-1/8-T0=2371-F
A9R62	0757-0316	6	1	RESISTOR 42.2 1% .125W F TC0+100	24546	C4-1/8-T0=42R2-F
A9R63	0757-0200	7		RESISTOR 5.62K 1% .125W F TC0+100	24546	C4-1/8-T0=5621-F
A9R64	0757-0438	3		RESISTOR 5.11K 1% .125W F TC0+100	24546	C4-1/8-T0=5111-F
A9R65	0757-0418	9		RESISTOR 619 1% .125W F TC0+100	24546	C4-1/8-T0=619R-F
A9R66	0757-0422	5	3	RESISTOR 909 1% .125W F TC0+100	24546	C4-1/8-T0=909R-F
A9R67	0757-0442	9		RESISTOR 10K 1% .125W F TC0+100	24546	C4-1/8-T0=1002-F
A9R68	0757-0443	0		RESISTOR 11K 1% .125W F TC0+100	24546	C4-1/8-T0=1102-F
A9R69	0698-3460	1	2	RESISTOR 422K 1% .125W F TC0+100	28480	0698-3460
A9R70	0698-3460	1		RESISTOR 422K 1% .125W F TC0+100	28480	0698-3460
A9R71	2100-3253	7		RESISTOR TRMR 50K 10% C TOP-ADJ 1-TRN	28480	2100-3253
A9R72	0698-3450	9	2	RESISTOR 42.2K 1% .125W F TC0+100	24546	C4-1/8-T0=4222-F
A9R73	0698-3456	5	1	RESISTOR 287K 1% .125W F TC0+100	24546	C4-1/8-T0=2873-F
A9R74	0757-0280	3		RESISTOR 1K 1% .125W F TC0+100	24546	C4-1/8-T0=1001-F
A9R75	0698-3160	8	5	RESISTOR 31.6K 1% .125W F TC0+100	24546	C4-1/8-T0=3162-F
A9R76	2100-3253	7		RESISTOR TRMR 50K 10% C TOP-ADJ 1-TRN	28480	2100-3253
A9R77	0757-0199	3		RESISTOR 21.5K 1% .125W F TC0+100	24546	C4-1/8-T0=2152-F
A9R78	0757-0442	9		RESISTOR 10K 1% .125W F TC0+100	24546	C4-1/8-T0=1002-F
A9R79	0698-0083	6		RESISTOR 1.96K 1% .125W F TC0+100	24546	C4-1/8-T0=1961-F
A9R80	0757-0280	3		RESISTOR 1K 1% .125W F TC0+100	24546	C4-1/8-T0=1001-F

See introduction to this section for ordering information
 *Indicates factory selected value

Table 6-2. REPLACEABLE PARTS

Reference Designation	HP Part Number	C D	Qty	Description	Mfr Code	Mfr Part Number
A9R81	0757-0280	3		RESISTOR 1K 1% .125W F TC0+100	24546	C4-1/8-T0=1001-F
A9R82	0757-0279	0		RESISTOR 3.16K 1% .125W F TC0+100	24546	C4-1/8-T0=3161-F
A9R83	0698-0083	6		RESISTOR 1.96K 1% .125W F TC0+100	24546	C4-1/8-T0=1961-F
A9R84	0698-0085	0		RESISTOR 2.61K 1% .125W F TC0+100	24546	C4-1/8-T0=2611-F
A9R85	0757-0443	0		RESISTOR 11K 1% .125W F TC0+100	24546	C4-1/8-T0=1102-F
A9R86	0757-0443	0		RESISTOR 11K 1% .125W F TC0+100	24546	C4-1/8-T0=1102-F
A9R87	0698-3158	4		RESISTOR 23.7K 1% .125W F TC0+100	24546	C4-1/8-T0=2372-F
A9R88	2100-3409	5	3	RESISTOR-TRMR 20 10X C TOP-ADJ 1-TRN	28480	2100-3409
A9R89	0757-0422	5		RESISTOR 909 1% .125W F TC0+100	24546	C4-1/8-T0=9098-F
A9R90	0757-0395	1	1	RESISTOR 56.2 1% .125W F TC0+100	24546	C4-1/8-T0=5622-F
A9R91	0757-0394	0		RESISTOR 51.1 1% .125W F TC0+100	24546	C4-1/8-T0=5111-F
A9R92	0757-0442	9		RESISTOR 10K 1% .125W F TC0+100	24546	C4-1/8-T0=1002-F
A9R93	0757-0442	9		RESISTOR 10K 1% .125W F TC0+100	24546	C4-1/8-T0=1002-F
A9R94	0698-3156	2		RESISTOR 14.7K 1% .125W F TC0+100	24546	C4-1/8-T0=1472-F
A9R95	2100-3252	6		RESISTOR-TRMR 5K 10X C TOP-ADJ 1-TRN	28480	2100-3252
A9R96	0757-0465	6		RESISTOR 100K 1% .125W F TC0+100	24546	C4-1/8-T0=1003-F
A9R97	0757-0442	9		RESISTOR 10K 1% .125W F TC0+100	24546	C4-1/8-T0=1002-F
A9R98	0757-0465	6		RESISTOR 100K 1% .125W F TC0+100	24546	C4-1/8-T0=1003-F
A9R99	0757-0442	9		RESISTOR 10K 1% .125W F TC0+100	24546	C4-1/8-T0=1002-F
A9R100-						
A9R105				NOT ASSIGNED		
A9R106	0757-0442	9		RESISTOR 10K 1% .125W F TC0+100	24546	C4-1/8-T0=1002-F
A9R107	0757-0428	1		RESISTOR 1.62K 1% .125W F TC0+100	24546	C4-1/8-T0=1621-F
A9R107	0698-3431	6		RESISTOR 23.7 1% .125W F TC0+100 (OPT 001 ONLY)	03888	PME55-1/8-T0=2372-F
A9R107	0698-4087	0	1	RESISTOR 24.6 1% .125W F TC0+100 (OPT 003 AND 011 ONLY)	03888	PME55-1/8-T0=2462-F
A9R108	0698-3637	4	1	RESISTOR 820 5% 2W MC TC0+200	28480	0698-3637
A9R109	0757-0442	9		RESISTOR 10K 1% .125W F TC0+100	24546	C4-1/8-T0=1002-F
A9R110	0757-0438	3		RESISTOR 5.11K 1% .125W F TC0+100	24546	C4-1/8-T0=5111-F
A9R111	0757-0442	9		RESISTOR 10K 1% .125W F TC0+100	24546	C4-1/8-T0=1002-F
A9R112	0698-3160	6		RESISTOR 31.6K 1% .125W F TC0+100	24546	C4-1/8-T0=3162-F
A9R112	0757-0465	6		RESISTOR 100K 1% .125W F TC0+100 (OPT 006 ONLY)	24546	C4-1/8-T0=1003-F
A9R113	0757-0378	0	2	RESISTOR 11 1% .125W F TC0+100	19701	MF4C1/8-T0=11R0-F
A9R113	0698-3428	1	2	RESISTOR 14.7 1% .125W F TC0+100 (OPT 001 AND 012 ONLY)	03888	PME55-1/8-T0=1472-F
A9R113	0683-0565	0	2	RESISTOR 5.6 5% .25W FC TC0=400/+500 (OPT 002 AND 011 ONLY)	01121	C85605
A9R114	0757-0442	9		RESISTOR 10K 1% .125W F TC0+100	24546	C4-1/8-T0=1002-F
A9R115	0757-0401	0		RESISTOR 100 1% .125W F TC0+100	24546	C4-1/8-T0=1011-F
A9R116	0757-0399	5		RESISTOR 82.5 1% .125W F TC0+100	24546	C4-1/8-T0=8251-F
A9R117	2100-3383	4	1	RESISTOR-TRMR 50 10X C TOP-ADJ 1-TRN	28480	2100-3383
A9R118	0757-0200	7		RESISTOR 5.62K 1% .125W F TC0+100	24546	C4-1/8-T0=5621-F
A9R119	0757-0418	9		RESISTOR 619 1% .125W F TC0+100	24546	C4-1/8-T0=619R-F
A9R120	2100-3409	5		RESISTOR-TRMR 20 10X C TOP-ADJ 1-TRN	28480	2100-3409
A9R121	0757-0402	1	1	RESISTOR 110 1% .125W F TC0+100	24546	C4-1/8-T0=1111-F
A9R122	0757-0447	4	2	RESISTOR 16.2K 1% .125W F TC0+100	24546	C4-1/8-T0=1622-F
A9R123	0698-6276	3	1	RESISTOR 12.5K 1% .125W F TC0+25	28480	0698-6276
A9R124				NOT ASSIGNED		
A9R125				NOT ASSIGNED		
A9R126	0698-4317	9	1	RESISTOR 5.62K 1% .5W F TC0+25	28480	0698-4317
A9R127				NOT ASSIGNED		
A9R128	0757-0317	7		RESISTOR 1.33K 1% .125W F TC0+100	24546	C4-1/8-T0=1331-F
A9R129	0698-3159	5		RESISTOR 26.1K 1% .125W F TC0+100	24546	C4-1/8-T0=2612-F
A9R130	2100-3409	5		RESISTOR-TRMR 20 10X C TOP-ADJ 1-TRN	28480	2100-3409
A9R131	2100-0558	9	3	RESISTOR-TRMR 20K 10X C TOP-ADJ 1-TRN	28480	2100-0558
A9R132	0757-0441	8		RESISTOR 8.25K 1% .125W F TC0+100	24546	C4-1/8-T0=8251-F
A9R133	0698-3159	5		RESISTOR 26.1K 1% .125W F TC0+100	24546	C4-1/8-T0=2612-F
A9R134	0757-1094	6	4	RESISTOR 1.47K 1% .125W F TC0+100	24546	C4-1/8-T0=1471-F
A9R135	0698-3449	9		RESISTOR 28.7K 1% .125W F TC0+100	24546	C4-1/8-T0=2872-F
A9R136	2100-0558	9		RESISTOR-TRMR 20K 10X C TOP-ADJ 1-TRN	28480	2100-0558
A9R137	0698-3156	2		RESISTOR 14.7K 1% .125W F TC0+100	24546	C4-1/8-T0=1472-F
A9R138	0698-3160	8		RESISTOR 31.6K 1% .125W F TC0+100	24546	C4-1/8-T0=3162-F
A9R139	0757-0416	7		RESISTOR 511 1% .125W F TC0+100	24546	C4-1/8-T0=511R-F
A9R140	0698-0082	7		RESISTOR 464 1% .125W F TC0+100	24546	C4-1/8-T0=4640-F
A9R141	0698-0082	7		RESISTOR 464 1% .125W F TC0+100	24546	C4-1/8-T0=4640-F
A9R142	0757-0289	2		RESISTOR 13.3K 1% .125W F TC0+100	19701	MF4C1/8-T0=1332-F
A9R143	0757-0470	3	1	RESISTOR 162K 1% .125W F TC0+100	24546	C4-1/8-T0=1623-F
A9R144	0757-0462	3	1	RESISTOR 75K 1% .125W F TC0+100	24546	C4-1/8-T0=7502-F
A9R145	0698-3160	8		RESISTOR 31.6K 1% .125W F TC0+100	24546	C4-1/8-T0=3162-F
A9R146	0698-3156	2		RESISTOR 14.7K 1% .125W F TC0+100	24546	C4-1/8-T0=1472-F
A9R147	0698-3155	1	1	RESISTOR 4.64K 1% .125W F TC0+100	24546	C4-1/8-T0=4641-F
A9R148	0757-0442	9		RESISTOR 10K 1% .125W F TC0+100	24546	C4-1/8-T0=1002-F
A9R149	0757-0839	8	2	RESISTOR 10K 1% .5W F TC0+100	28480	0757-0839
A9R150	0698-3449	6		RESISTOR 28.7K 1% .125W F TC0+100	24546	C4-1/8-T0=2872-F
A9R151	0757-0416	7		RESISTOR 511 1% .125W F TC0+100	24546	C4-1/8-T0=511R-F
A9R152	0757-1094	9		RESISTOR 1.47K 1% .125W F TC0+100	24546	C4-1/8-T0=1471-F
A9R153	0757-0199	3		RESISTOR 21.5K 1% .125W F TC0+100	24546	C4-1/8-T0=2152-F

See introduction to this section for ordering information
*Indicates factory selected value

Table 6-2. REPLACEABLE PARTS

Reference Designation	HP Part Number	C D	Qty	Description	Mfr Code	Mfr Part Number
A9R154	0757-1094	9		RESISTOR 1.47K 1% .125W F TC0+100	24546	C4=1/8-T0=1471-F
A9R155	0757-0444	1		RESISTOR 12.1K 1% .125W F TC0+100	24546	C4=1/8-T0=1212-F
A9R156	0757-0199	3		RESISTOR 21.5K 1% .125W F TC0+100	24546	C4=1/8-T0=2152-F
A9R157	0757-1094	9		RESISTOR 1.47K 1% .125W F TC0+100	24546	C4=1/8-T0=1471-F
A9R158	0757-0442	9		RESISTOR 10K 1% .125W F TC0+100	24546	C4=1/8-T0=1002-F
A9R159	0698-3160	8		RESISTOR 31.6K 1% .125W F TC0+100	24546	C4=1/8-T0=3162-F
A9R159	0698-3449	6		RESISTOR 28.7K 1% .125W F TC0+100 (OPTION 005 ONLY)	24546	C4=1/8-T0=2872-F
A9R160	2100-3210	6	2	RESISTOR-TRMR 10K 10% C TOP=ADJ 1-TRN	28480	2100-3210
A9R161	0757-0464	5	1	RESISTOR 90.9K 1% .125W F TC0+100	24546	C4=1/8-T0=9092-F
A9R162	2100-3210	8		RESISTOR-TRMR 10K 10% C TOP=ADJ 1-TRN	28480	2100-3210
A9R162	2100-0969	6	1	RESISTOR-TRMR 50K 20% MG TOP=ADJ 1-TRN (OPT 001,002 AND 013 ONLY)	28480	2100-0969
A9R163	0757-0442	9		RESISTOR 10K 1% .125W F TC0+100	24546	C4=1/8-T0=1002-F
A9R163	0757-0438	3		RESISTOR 5.11K 1% .125W F TC0+100 (OPTION 005 ONLY)	24546	C4=1/8-T0=5111-F
A9R164	0698-3154	0	2	RESISTOR 4.22K 1% .125W F TC0+100	24546	C4=1/8-T0=4221-F
A9R165	0757-0442	9		RESISTOR 10K 1% .125W F TC0+100	24546	C4=1/8-T0=1002-F
A9R166	0698-3260	9		RESISTOR 464K 1% .125W F TC0+100	28480	0698-3260
A9R167	0698-3410	1		RESISTOR 3.16K 1% .5W F TC0+100	28480	0698-3410
A9R168	0698-3417	8	2	RESISTOR 23.7K 1% .5W F TC0+100	28480	0698-3417
A9R169	0757-0440	7		RESISTOR 7.5K 1% .125W F TC0+100	24546	C4=1/8-T0=7501-F
A9R170	0757-0442	9		RESISTOR 10K 1% .125W F TC0+100	24546	C4=1/8-T0=1002-F
A9R171	0698-0084	9	2	RESISTOR 2.15K 1% .125W F TC0+100	24546	C4=1/8-T0=2151-F
A9R172	0757-0394	0		RESISTOR 51.1 1% .125W F TC0+100	24546	C4=1/8-T0=5111-F
A9R173	0757-0397	3	1	RESISTOR 66.1 1% .125W F TC0+100	24546	C4=1/8-T0=6611-F
A9R174	0757-0280	3		RESISTOR 1K 1% .125W F TC0+100	24546	C4=1/8-T0=1001-F
A9R175	0757-0280	3		RESISTOR 1K 1% .125W F TC0+100	24546	C4=1/8-T0=1001-F
A9R176	0757-0180	2	1	RESISTOR 31.6 1% .125W F TC0+100	28480	0757-0180
A9R177	0698-3154	0		RESISTOR 4.22K 1% .125W F TC0+100	24546	C4=1/8-T0=4221-F
A9R178	0811-0983	9	1	RESISTOR 180 3% 4W PW TC0+20	28480	0811-0983
A9R179	0757-0280	3		RESISTOR 1K 1% .125W F TC0+100	24546	C4=1/8-T0=1001-F
A9R180	0757-0442	9		RESISTOR 10K 1% .125W F TC0+100	24546	C4=1/8-T0=1002-F
A9R181	2100-0558	9		RESISTOR-TRMR 20K 10% C TOP=ADJ 1-TRN	28480	2100-0558
A9R182	0757-0394	0		RESISTOR 51.1 1% .125W F TC0+100	24546	C4=1/8-T0=5111-F
A9R183	2100-2497	9	1	RESISTOR-TRMR 2K 10% C TOP=ADJ 1-TRN	73138	82PR2K
A9R184	0757-0442	9		RESISTOR 10K 1% .125W F TC0+100	24546	C4=1/8-T0=1002-F
A9R185	0698-3161	9		RESISTOR 38.3K 1% .125W F TC0+100	24546	C4=1/8-T0=3832-F
A10	08601-6020	1	1	BOARD ASSEMBLY-POWER SUPPLY	28480	08601-6020
A10C1	0180-0100	3	1	CAPACITOR-FXD 4.7UF+10% 35VDC TA	56289	150D475X9035B2
A10C2	0180-0161	6	4	CAPACITOR-FXD 3.3UF+10% 35VDC TA	09098	T1108335K035A8
A10C3	0180-0094	4	2	CAPACITOR-FXD 100UF+75% 10% 25VDC AL	56289	30D107G025D02
A10C4	0180-0161	6	6	CAPACITOR-FXD 3.3UF+10% 35VDC TA	09098	T1108335K035A8
A10C5	0160-2055	9		CAPACITOR-FXD .01UF +80-20% 100VDC CER	28480	0160-2055
A10C6	0180-0097	7		CAPACITOR-FXD 47UF+10% 35VDC TA	56289	150D476X9035B2
A10C7	0180-1743	2		CAPACITOR-FXD .1UF+10% 35VDC TA	56289	150D104X9035A2
A10C8	0180-0097	7		CAPACITOR-FXD 47UF+10% 35VDC TA	56289	150D476X9035B2
A10C9	0180-1797	6	1	CAPACITOR-FXD 50UF+50-10% 150VDC AL	56289	39D506F150FJ4
A10C10	0180-0094	4		CAPACITOR-FXD 100UF+75-10% 25VDC AL	56289	30D107G025D02
A10C11	0180-0089	7	2	CAPACITOR-FXD 10UF+50-10% 150VDC AL	56289	30D106F150D02
A10C12	0180-0089	7		CAPACITOR-FXD 10UF+50-10% 150VDC AL	56289	30D106F150D02
A10CR1	1902-3036	3	2	DIODE-ZNR 3.16V 5% DO-7 PDR.4W TC=+.064% DIODE-GEN PRP 180V 200MA DO-7	28480	1902-3036
A10CR2	1901-0033	2		DIODE-GEN PRP 180V 200MA DO-7	28480	1901-0033
A10CR3	1901-0033	2		DIODE-GEN PRP 180V 200MA DO-7	28480	1901-0033
A10CR4	1901-0033	2		DIODE-GEN PRP 180V 200MA DO-7	28480	1901-0033
A10CR5	1901-0033	2		DIODE-GEN PRP 180V 200MA DO-7	28480	1901-0033
A10CR6	1902-0071	0	1	DIODE-ZNR 9V 5% DO-14 PDR.4W TC=+.001% DIODE-GEN PRP 180V 200MA DO-7	28480	1902-0071
A10CR7	1901-0033	2		DIODE-GEN PRP 180V 200MA DO-7	28480	1901-0033
A10CR8	1901-0033	2		DIODE-GEN PRP 180V 200MA DO-7	28480	1901-0033
A10CR9	1902-3036	3		DIODE-ZNR 3.16V 5% DO-7 PDR.4W TC=+.064% DIODE-ZNR 6.98V 2% DO-7 PDR.4W TC=+.045%	28480	1902-3036
A10CR10	1902-3125	1	1	DIODE-ZNR 6.98V 2% DO-7 PDR.4W TC=+.045%	28480	1902-3125
A10CR11	1901-0033	2		DIODE-GEN PRP 180V 200MA DO-7	28480	1901-0033
A10CR12	1901-0033	2		DIODE-GEN PRP 180V 200MA DO-7	28480	1901-0033
A10CR13	1901-0033	2		DIODE-GEN PRP 180V 200MA DO-7	28480	1901-0033
A10CR14	1901-0033	2		DIODE-GEN PRP 180V 200MA DO-7	28480	1901-0033
A10Q1	1854-0221	9		TRANSISTOR-DUAL NPN PDR750MHZ	28480	1854-0221
A10Q2	1854-0071	7		TRANSISTOR NPN SI PDR300MHZ FT=200MHZ	28480	1854-0071
A10Q3	1853-0001	1	1	TRANSISTOR PNP SI TO-39 PDR600MHZ	28480	1853-0001
A10Q4	1853-0010	2		TRANSISTOR PNP SI TO-18 PDR360MHZ	28480	1853-0010
A10Q5	1854-0071	7		TRANSISTOR NPN SI PDR300MHZ FT=200MHZ	28480	1854-0071
A10Q6	1853-0037	3	2	TRANSISTOR PNP SI TO-39 PDR1W FT=100MHZ	28480	1853-0037
A10Q7	1854-0022	8		TRANSISTOR NPN SI TO-39 PDR700MHZ	07263	817843
A10Q8	1853-0037	3		TRANSISTOR PNP SI TO-39 PDR1W FT=100MHZ	28480	1853-0037
A10Q9	1854-0039	7	1	TRANSISTOR NPN 2N3053 SI TO-39 PDR1W	01928	2N3053B
A10Q10	1854-0221	9		TRANSISTOR-DUAL NPN PDR750MHZ	28480	1854-0221

See introduction to this section for ordering information
*Indicates factory selected value

Table 6-2. REPLACEABLE PARTS

Reference Designation	HP Part Number	C D	Qty	Description	Mfr Code	Mfr Part Number
A10011	1854-0071	7		TRANSISTOR NPN SI PD=300MH F \approx 200MHZ	28480	1854-0071
A10012	1853-0010	2		TRANSISTOR PNP SI TD=18 PD=360MH	28480	1853-0010
A10013	1853-0010	2		TRANSISTOR PNP SI TD=18 PD=360MH	28480	1853-0010
A10R1	0757-0839	8		RESISTOR 10K 1% .5W F TC=0 \pm 100	28480	0757-0839
A10R2	0698-3434	9	1	RESISTOR 34.8 1% .125W F TC=0 \pm 100	24546	C4=1/8-T0=34R0=F
A10R3	0757-0346	2		RESISTOR 10 1% .125W F TC=0 \pm 100	24546	C4=1/8-T0=10R0=F
A10R4	0761-0047	9	1	RESISTOR 130 5% 1W MO TC=0 \pm 200	28480	0761-0047
A10R5	0761-0048	0	1	RESISTOR 160 5% 1W MO TC=0 \pm 200	28480	0761-0048
A10R6	0757-0280	3		RESISTOR 1K 1% .125W F TC=0 \pm 100	24546	C4=1/8-T0=1001=F
A10R7	0698-3157	3		RESISTOR 19.6K 1% .125W F TC=0 \pm 100	24546	C4=1/8-T0=1962=F
A10R8	0757-0442	9		RESISTOR 10K 1% .125W F TC=0 \pm 100	24546	C4=1/8-T0=1002=F
A10R9	0757-0280	3		RESISTOR 1K 1% .125W F TC=0 \pm 100	24546	C4=1/8-T0=1001=F
A10R10	0757-0447	4		RESISTOR 16.2K 1% .125W F TC=0 \pm 100	24546	C4=1/8-T0=1622=F
A10R11	2100-1773	2	1	RESISTOR-YMR 1K 5% HW TOP=ADJ I=TRN	28480	2100-1773
A10R12	0757-0441	3		RESISTOR 8.25K 1% .125W F TC=0 \pm 100	24546	C4=1/8-T0=8251=F
A10R13	0757-0465	6		RESISTOR 100K 1% .125W F TC=0 \pm 100	24546	C4=1/8-T0=1003=F
A10R14	0757-0465	6		RESISTOR 100K 1% .125W F TC=0 \pm 100	24546	C4=1/8-T0=1003=F
A10R15	0698-3450	9		RESISTOR 42.2K 1% .125W F TC=0 \pm 100	24546	C4=1/8-T0=4222=F
A10R16	0757-0280	3		RESISTOR 1K 1% .125W F TC=0 \pm 100	24546	C4=1/8-T0=1001=F
A10R17	0698-3409	A	1	RESISTOR 2.37K 1% .5W F TC=0 \pm 100	28480	0698-3409
A10R18	0698-3157	3		RESISTOR 19.6K 1% .125W F TC=0 \pm 100	24546	C4=1/8-T0=1962=F
A10R19	0757-0290	5	1	RESISTOR 6.19K 1% .125W F TC=0 \pm 100	19701	MF4C1/8-T0=6191=F
A10R20	0698-3243	8	1	RESISTOR 178K 1% .125W F TC=0 \pm 100	24546	C4=1/8-T0=1783=F
A10R21	0698-3449	6		RESISTOR 28.7K 1% .125W F TC=0 \pm 100	24546	C4=1/8-T0=2872=F
A10R22	0757-0442	9		RESISTOR 10K 1% .125W F TC=0 \pm 100	24546	C4=1/8-T0=1002=F
A10R23	0757-0280	3		RESISTOR 1K 1% .125W F TC=0 \pm 100	24546	C4=1/8-T0=1001=F
A10R24	0698-3158	4		RESISTOR 23.7K 1% .125W F TC=0 \pm 100	24546	C4=1/8-T0=2372=F
A10R25	0698-0084	9		RESISTOR 2.15K 1% .125W F TC=0 \pm 100	24546	C4=1/8-T0=2151=F
A10R26	0698-3153	9		RESISTOR 3.83K 1% .125W F TC=0 \pm 100	24546	C4=1/8-T0=3831=F
A10R27	0757-0280	3		RESISTOR 1K 1% .125W F TC=0 \pm 100	24546	C4=1/8-T0=1001=F
A10R28	0757-0401	0		RESISTOR 100 1% .125W F TC=0 \pm 100	24546	C4=1/8-T0=1001=F
A10R29	0757-0401	0		RESISTOR 100 1% .125W F TC=0 \pm 100	24546	C4=1/8-T0=1001=F
A10R30	0811-1675	8	1	RESISTOR 5.6 5% 2W PW TC=0 \pm 400	75042	BW2=5R8=J
A10R31	0698-3417	8		RESISTOR 23.7K 1% .5W F TC=0 \pm 100	28480	0698-3417
A10R32	0757-0417	8		RESISTOR 562 1% .125W F TC=0 \pm 100	24546	C4=1/8-T0=562R=F
A10R33	0698-3416	7	1	RESISTOR 21.5K 1% .5W F TC=0 \pm 100	28480	0698-3416
A10R34	0698-3150	6		RESISTOR 2.37K 1% .125W F TC=0 \pm 100	24546	C4=1/8-T0=2371=F
A11	08601-6010	0	1	SWITCH ASSEMBLY-SWEEP WIDTH	28480	08601-6010
A11R1	0757-0123	3	1	RESISTOR 34.8K 1% .125W F TC=0 \pm 100	28480	0757-0123
A11R2	0698-6998	6	1	RESISTOR 6.75K 1% .125W F TC=0 \pm 100	28480	0698-6998
A11R3	0757-0427	0	1	RESISTOR 1.5K 1% .125W F TC=0 \pm 100	24546	C4=1/8-T0=1501=F
A11R4	0698-6999	7	1	RESISTOR 371 1% .125W F TC=0 \pm 100	24546	C4=1/8-T0=3710=F
A11R5	0698-4417	0	1	RESISTOR 174 1% .125W F TC=0 \pm 100	24546	C4=1/8-T0=174R=F
A11R6	2100-2424	2	1	RESISTOR-VAR W/3W 50K 10% LIN 3PST=NO	28480	2100-2424
A11R7*	0698-4307	7	1	RESISTOR 14.3K 1% .125W F TC=0 \pm 100	24546	C4=1/8-T0=1432=F
A11R8	0698-3156	2		RESISTOR 14.7K 1% .125W F TC=0 \pm 100	24546	C4=1/8-T0=1472=F
A11R9	0757-0416	7		RESISTOR 511 1% .125W F TC=0 \pm 100	24546	C4=1/8-T0=511R=F
A11S1	3100-2088	5	1	SWITCH=ROTARY 1.031 STRUT CTR SPCG; 6	28480	3100-2088
	08601-00053	2	1	DIAL=KNOB ASSEMBLY=SYM, SWEEP WIDTH	28480	08601-00053
A12	08601-6027	5	1	SWITCH ASSEMBLY=FUNCTION	28480	08601-6027
A12C1	0180-0106	9	2	CAPACITOR-FXD 60UF \pm 20% 6VDC TA	56289	150D806X000682
A12C1	0180-0116	1		CAPACITOR-FXD 6.8UF \pm 10% 35VDC TA (OPT'S 001, 002, AND 011)	56289	150D685X903582
A12C2	0180-0291	3		CAPACITOR-FXD 1UF \pm 10% 35VDC TA	56289	150D105X903542
A12C3	0180-0106	9		CAPACITOR-FXD 60UF \pm 20% 6VDC TA	56289	150D806X000682
A12R1	0757-0280	3		RESISTOR 1K 1% .125W F TC=0 \pm 100	24546	C4=1/8-T0=1001=F
A12R2	0757-0378	0		RESISTOR 11 1% .125W F TC=0 \pm 100	19701	MF4C1/8-T0=11R0=F
A12R2	0698-3428	1		RESISTOR 14.7 1% .125W F TC=0 \pm 100 (OPT 001 ONLY)	03888	PME53=1/8-T0=14R7=F
A12R2	0683-0565	0		RESISTOR 5.6 5% .25W FC TC=400/ \pm 500 (OPT 002 AND 011 ONLY)	01121	CB5605
A1281	3100-2464	1	1	SWITCH=ROTARY LEVER 1.250 MTG CTR SPCG	28480	3100-2464
	0370-0433	8	1	KNOB LEVER SWITCH .200 X .220 X .375IN	28480	0370-0433
	08601-6066	7	1	SWITCH ASSEMBLY=FUNCTION (OPT. 001)	28480	08601-6066
	08601-6067	9	1	SWITCH ASSEMBLY=FUNCTION(OPT'S 002 & 011)	28480	08601-6067
A13	08601-6011	2	1	FREQUENCY READOUT ASSEMBLY (SEE FIGURE 6-1)	28480	08601-6011
A13-1	1140-0006	5	1	NUMBER WHEEL RANGE=0-9	28480	1140-0006
A13-2	08601-20101	3	1	WHEEL-END COUNTER 0 TO 9 NUMERALS	28480	08601-20101
A13-3	1140-0044	1	1	WHEEL=UNIT 0 TO 9 NUMERALS	28480	1140-0044
A13-4	1410-0142	3	1	BUSHING=BEARING, FLANGED	71041	FB=46=5
A13-5	1430-0035	5	2	GEAR=STEM=PIN 22=DP 20=DEG=PA NYLTR	18911	BB=2219

See introduction to this section for ordering information
*Indicates factory selected value

Table 6-2. REPLACEABLE PARTS

Reference Designation	HP Part Number	C D	Qty	Description	Mfr Code	Mfr Part Number
A13-6	1430-0064	0	2	GEAR-MIT 16-T 32-DP 20-DEG-PA BR8	28480	1430-0064
A13-7	2100-2335	4	1	RESISTOR-VAR PREC WW 10-TRN 1K 3X	28480	2100-2335
A13-8	2140-0092	0	2	LAMP-INCCAND 685 5VDC 60MA T-1-BULB	0000J	685 TYP END
A13-9	00695-285	0	1	GEAR STOP-OFFSET	28480	00695-285
A13-10	08614-218	8	1	SPACER-SHOULDERED	28480	08614-218
A13-11	08601-0004	1	2	CONTACT-LAMP	28480	08601-0004
A13-12	08601-2005	5	1	SUPPORT-READOUT	28480	08601-2005
A13-13	08601-2006	7	1	SHAFT-READOUT	28480	08601-2006
A13-14	08601-2007	9	1	SHAFT-KNOB	28480	08601-2007
A13-15	08601-2008	1	1	SHAFT-DRIVE	28480	08601-2008
A13-16	08601-2012	0	1	GEAR-PDT	28480	08601-2012
A13-17	08601-2013	2	1	GEAR-SHAFT READOUT	28480	08601-2013
A13-18	08601-2014	4	1	GEAR-SHAFT DRIVE	28480	08601-2014
A13-19	08601-2015	6	1	GEAR STOP	28480	08601-2015
A13-20	08601-2032	2	1	SHAFT-PINION	28480	08601-2032
A13-21	0510-0091	2	2	RETAINER-RING CR8NT EXT .25-IN-DIA STL	28480	0510-0091
A13-22	0570-0034	9	2	SCREW-MACH 4-40 .25-IN-LG RD-HD-SLT	00000	ORDER BY DESCRIPTION
A13-23	1480-0072	5	1	PIN-ROLL .062-IN-DIA .375-IN-LG BE-CU	28480	1480-0072
A13-24	2190-0006	1	1	WASHER=LK HLCL NO. 6 .141-IN-ID	28480	2190-0006
A13-25	2190-0016	3	1	WASHER=LK INTL Y 3/8 IN .377-IN-ID	28480	2190-0016
A13-26	2190-0401	0	2	WASHER-FL NM NO. 4 .12-IN-ID .312-IN-OD	28480	2190-0401
A13-27	2360-0197	2	1	SCREW-MACH 6-32 .375-IN-LG PAN-HD-POZI	00000	ORDER BY DESCRIPTION
A13-28	2950-0001	8	1	NUT-HEX-DBL-CHAM 3/8-32-THD .094-IN-THK	00000	ORDER BY DESCRIPTION
A13-29	3030-0022	4	8	SCREW-SET 6-32 .125-IN-LG SMALL CUP-PT	00000	ORDER BY DESCRIPTION
A13-30	3050-0017	9	8	WASHER-FL MTLG 1/4 IN .26-IN-ID	28480	3050-0017
A13-31	3050-0066	8	1	WASHER-FL MTLG NO. 6 .147-IN-ID	28480	3050-0066
A13-32	3050-0161	4	1	WASHER-8PR WAVY 1/4 IN .265-IN-ID	28480	3050-0161
A13-33	3050-0177	2	1	WASHER-FL MTLG NO. 5 .185-IN-ID	28480	3050-0177
A13-34	9300-0048	3	1	PIPE-FLEXIBLE LIGHT	8747D	EP127 CORD
A14	08601-6047	7	1	BROADBAND AMPLIFIER ASSEMBLY (INCL C1, J1-2, A14A1 ASSY & COVER) (OPT 007 ONLY)	28480	08601-6047
A14	08601-2051	2	1	BOX-BB AMPLIFIER ASSEMBLY-SHIELD	28480	08601-2051
A14C1	0160-2049	1	1	CAPACITOR-FDTHRU 5000PF +80 -20% 500V	33095	54-743-009-X5V0-5022
A14J1	1250-0829	3	1	CONNECTOR-RF 5VC M 3GL-HOLE-FR 50-OHM	28480	1250-0829
A14J2	1250-0829	3	1	CONNECTOR-RF 5VC M 3GL-HOLE-FR 50-OHM	28480	1250-0829
A14A1	08601-6046	5	1	BOARD ASSEMBLY-BROADBAND AMPLIFIER	28480	08601-6046
A14A1C1	0150-0050	9	1	CAPACITOR-FXD 1000PF +80-20% 1KVDC CER	28480	0150-0050
A14A1C2	0150-0050	9	1	CAPACITOR-FXD 1000PF +80-20% 1KVDC CER	28480	0150-0050
A14A1C3	0150-0050	9	1	CAPACITOR-FXD 1000PF +80-20% 1KVDC CER	28480	0150-0050
A14A1C4	0160-2266	4	1	CAPACITOR-FXD 24PF +-5% 500VDC CER 0+-30	28480	0160-2266
A14A1C5	0150-0050	9	1	CAPACITOR-FXD 1000PF +80-20% 1KVDC CER	28480	0150-0050
A14A1C6	0150-0050	9	1	CAPACITOR-FXD 1000PF +80-20% 1KVDC CER	28480	0150-0050
A14A1C7*	0160-2256	6	1	CAPACITOR-FXD 5.1PF 500VDC CER	72982	361-008-COHQ-519C
A14A1CA	0150-0050	9	1	CAPACITOR-FXD 1000PF +80-20% 1KVDC CER	28480	0150-0050
A14A1C9	0150-0050	9	1	CAPACITOR-FXD 1000PF +80-20% 1KVDC CER	28480	0150-0050
A14A1C10	0150-0050	9	1	CAPACITOR-FXD 1000PF +80-20% 1KVDC CER	28480	0150-0050
A14A1L1				NBR,P/O BD ASSY, TYPICAL VALUE 20/30NH		
A14A1L2				NBR,P/O BD ASSY, TYPICAL VALUE 20/30NH		
A14A1L3	9100-2247	4	1	COIL-MLD 100NH 10% Q934 .095DX.25LG-NOM	28480	9100-2247
A14A1Q1	1854-0345	8	1	TRANSISTOR NPN 2N5179 SI TC=72 PD=200MW	04713	2N5179
A14A1Q2	1854-0345	8	1	TRANSISTOR NPN 2N5179 SI TC=72 PD=200MW	04713	2N5179
A14A1Q3	1854-0345	8	1	TRANSISTOR NPN 2N5179 SI TC=72 PD=200MW	04713	2N5179
A14A1R1	0683-6805	3	1	RESISTOR 68 5% .25W FC TC=400/+500	01121	C86805
A14A1R2	0683-5625	3	4	RESISTOR 5.6K 5% .25W FC TC=400/+700	01121	C85625
A14A1R3	0683-5625	3	1	RESISTOR 5.6K 5% .25W FC TC=400/+700	01121	C85625
A14A1R4	0683-5605	9	3	RESISTOR 56 5% .25W FC TC=400/+500	01121	C85605
A14A1R5	0683-8215	3	2	RESISTOR 820 5% .25W FC TC=400/+600	01121	C88215
A14A1R6	0683-5625	3	1	RESISTOR 5.6K 5% .25W FC TC=400/+700	01121	C85625
A14A1R7	0683-5625	3	1	RESISTOR 5.6K 5% .25W FC TC=400/+700	01121	C85625
A14A1R8	0683-1015	7	1	RESISTOR 100 5% .25W FC TC=400/+500	01121	C81015
A14A1R9	0683-5605	9	1	RESISTOR 56 5% .25W FC TC=400/+500	01121	C85605
A14A1R10	0683-8215	3	1	RESISTOR 820 5% .25W FC TC=400/+600	01121	C88215
A14A1R11	0683-3325	6	1	RESISTOR 3.3K 5% .25W FC TC=400/+700	01121	C83325
A14A1R12	0683-1035	1	1	RESISTOR 10K 5% .25W FC TC=400/+700	01121	C81035
A14A1R13	0683-5605	9	1	RESISTOR 56 5% .25W FC TC=400/+500	01121	C85605
A14A1R14	0683-2715	6	1	RESISTOR 270 5% .25W FC TC=400/+600	01121	C82715
A14A1R15	0683-1525	4	2	RESISTOR 1.5K 5% .25W FC TC=400/+700	01121	C81525
A14A1R16	0683-1525	4	1	RESISTOR 1.5K 5% .25W FC TC=400/+700	01121	C81525

See introduction to this section for ordering information
*Indicates factory selected value

Table 6-2. REPLACEABLE PARTS

Reference Designation	HP Part Number	C D	Qty	Description	Mfr Code	Mfr Part Number
A15	08601-6062	9	1	AM/FM MONITOR ASSEMBLY (OPT 001 AND 012 ONLY)	28480	08601-6062
A15	08601-6075	6	1	AM/FM MONITOR ASSEMBLY (OPT 002 AND 011 ONLY)	28480	08601-6075
A15C1	0180-1743	2		CAPACITOR-FXD .1UF+10% 35VDC TA	56289	150D104X9035A2
A15C2	0160-0154	5	2	CAPACITOR-FXD 2700PF +10% 200VDC POLYE	28480	0160-0154
A15C3	0180-2206	4	1	CAPACITOR-FXD 60UF+10% 6VDC TA	56289	150D060X900682
A15C4				NOT ASSIGNED		
A15C5	0160-0203	5	1	CAPACITOR-FXD 150PF +1% 300VDC MICA	28480	0160-0203
A15C6	0160-3471	5	1	CAPACITOR-FXD 1060PF +1% 300VDC MICA	28480	0160-3471
A15C7	0180-0374	3		CAPACITOR-FXD 10UF+10% 20VDC TA	56289	150D106X9020B2
A15C8	0180-0197	8		CAPACITOR-FXD 2.2UF+10% 20VDC TA	56289	150D225X9020A2
A15C9	0160-2055	9		CAPACITOR-FXD .01UF +80-20% 100VDC CER	28480	0160-2055
A15C10	0160-2055	9		CAPACITOR-FXD .01UF +80-20% 100VDC CER	28480	0160-2055
A15C11	0160-0154	5		CAPACITOR-FXD 2200PF +10% 200VDC POLYE	28480	0160-0154
A15C12	0180-2208	6	1	CAPACITOR-FXD 220UF+10% 10VDC TA	56289	150D227X901082
A15C13	0180-0374	3		CAPACITOR-FXD 10UF+10% 20VDC TA	56289	150D106X9020B2
A15C14	0180-0374	3		CAPACITOR-FXD 10UF+10% 20VDC TA	56289	150D106X9020B2
A15C15	0180-0197	8		CAPACITOR-FXD 2.2UF+10% 20VDC TA	56289	150D225X9020A2
A15C16	0180-0197	8		CAPACITOR-FXD 2.2UF+10% 20VDC TA	56289	150D225X9020A2
A15CR1	1901-0050	3	6	DIODE-SWITCHING 80V 200MA 2N8 00-35	28480	1901-0050
A15CR2	1901-0050	3		DIODE-SWITCHING 80V 200MA 2N8 00-35	28480	1901-0050
A15CR3	1901-0050	3		DIODE-SWITCHING 80V 200MA 2N8 00-35	28480	1901-0050
A15CR4	1901-0050	3		DIODE-SWITCHING 80V 200MA 2N8 00-35	28480	1901-0050
A15CR5	1901-0050	3		DIODE-SWITCHING 80V 200MA 2N8 00-35	28480	1901-0050
A15CR6	1901-0050	3		DIODE-SWITCHING 80V 200MA 2N8 00-35	28480	1901-0050
A15L1	9140-0237	2		COIL-MLD 200UH 5% Q=65 .155DX.375LG-NOM	28480	9140-0237
A15L2	9140-0237	2		COIL-MLD 200UH 5% Q=65 .155DX.375LG-NOM	28480	9140-0237
A15Q1	1854-0071	7		TRANSISTOR NPN SI PD=300MH FT=200MHZ	28480	1854-0071
A15Q2	1855-0020	6	4	TRANSISTOR J-FET N-CHAN D-MODE TO-18 SI	28480	1855-0020
A15Q3	1855-0020	6		TRANSISTOR J-FET N-CHAN D-MODE TO-18 SI	28480	1855-0020
A15Q4	1855-0020	6		TRANSISTOR J-FET N-CHAN D-MODE TO-18 SI	28480	1855-0020
A15Q5	1854-0071	7		TRANSISTOR NPN SI PD=300MH FT=200MHZ	28480	1854-0071
A15Q6	1854-0071	7		TRANSISTOR NPN SI PD=300MH FT=200MHZ	28480	1854-0071
A15Q7	1855-0020	8		TRANSISTOR J-FET N-CHAN D-MODE TO-18 SI	28480	1855-0020
A15Q8	1855-0062	8	1	TRANSISTOR J-FET N-CHAN D-MODE 8I	28480	1855-0062
A15R1	0693-5145	2	2	RESISTOR 510K 5% .25W FC TC=800/+900	01121	C85145
A15R2	0757-0458	7		RESISTOR 51.1K 1% .125W F TC=0/+100	24546	C4=1/8-T0=5112-F
A15R3	0757-0280	3		RESISTOR 1K 1% .125W F TC=0/+100	24546	C4=1/8-T0=1001-F
A15R4	0757-0280	3		RESISTOR 1K 1% .125W F TC=0/+100	24546	C4=1/8-T0=1001-F
A15R5	0757-0440	7		RESISTOR 7.5K 1% .125W F TC=0/+100 (OPT 001 ONLY)	24546	C4=1/8-T0=7501-F
A15R6	0698-3159	5		RESISTOR 26.1K 1% .125W F TC=0/+100 (OPT 002 AND 011 ONLY)	24546	C4=1/8-T0=2612-F
A15R7	0757-0442	9		RESISTOR 10K 1% .125W F TC=0/+100	24546	C4=1/8-T0=1002-F
A15R8	0757-0422	5		RESISTOR 909 1% .125W F TC=0/+100	24546	C4=1/8-T0=909R-F
A15R9	0757-0288	1	1	RESISTOR 9.09K 1% .125W F TC=0/+100	19701	MF4C1/8-T0=9091-F
A15R9	0757-0442	9		RESISTOR 10K 1% .125W F TC=0/+100	24546	C4=1/8-T0=1002-F
A15R10	0757-0280	3		RESISTOR 1K 1% .125W F TC=0/+100	24546	C4=1/8-T0=1001-F
A15R11	0757-0401	0		RESISTOR 100 1% .125W F TC=0/+100	24546	C4=1/8-T0=101-F
A15R12	0757-0280	3		RESISTOR 1K 1% .125W F TC=0/+100	24546	C4=1/8-T0=1001-F
A15R13	0698-3159	5		RESISTOR 26.1K 1% .125W F TC=0/+100	24546	C4=1/8-T0=2612-F
A15R14	0757-0279	0		RESISTOR 3.16K 1% .125W F TC=0/+100	24546	C4=1/8-T0=3161-F
A15R15	2100-2489	9	2	RESISTOR-TRMR 5K 10% C SIDE=ADJ 1-TRN	30983	E750X502
A15R16	0757-0442	9		RESISTOR 10K 1% .125W F TC=0/+100	24546	C4=1/8-T0=1002-F
A15R17	0757-0442	9		RESISTOR 10K 1% .125W F TC=0/+100	24546	C4=1/8-T0=1002-F
A15R18	0757-0442	9		RESISTOR 10K 1% .125W F TC=0/+100	24546	C4=1/8-T0=1002-F
A15R19	0698-3454	3		RESISTOR 215K 1% .125W F TC=0/+100	24546	C4=1/8-T0=2153-F
A15R20	0683-5145	2		RESISTOR 510K 5% .25W FC TC=800/+900	01121	C85145
A15R21	0757-0442	9		RESISTOR 10K 1% .125W F TC=0/+100	24546	C4=1/8-T0=1002-F
A15R22	2100-2489	9		RESISTOR-TRMR 5K 10% C SIDE=ADJ 1-TRN	30983	E750X502
A15R23	0757-0280	3		RESISTOR 1K 1% .125W F TC=0/+100	24546	C4=1/8-T0=1001-F
A15R24	0757-0458	7		RESISTOR 51.1K 1% .125W F TC=0/+100	24546	C4=1/8-T0=5112-F
A15R25	0757-0458	7		RESISTOR 51.1K 1% .125W F TC=0/+100	24546	C4=1/8-T0=5112-F
A15R26	0757-0280	3		RESISTOR 1K 1% .125W F TC=0/+100	24546	C4=1/8-T0=1001-F
A15R27	0757-0458	7		RESISTOR 51.1K 1% .125W F TC=0/+100	24546	C4=1/8-T0=5112-F
A15R28	0757-0280	3		RESISTOR 1K 1% .125W F TC=0/+100	24546	C4=1/8-T0=1001-F
A15R29	0757-0442	9		RESISTOR 10K 1% .125W F TC=0/+100	24546	C4=1/8-T0=1002-F
A15R30	0757-0442	9		RESISTOR 10K 1% .125W F TC=0/+100	24546	C4=1/8-T0=1002-F
A15R31	0757-0401	0		RESISTOR 100 1% .125W F TC=0/+100	24546	C4=1/8-T0=101-F
A15R32	0757-0442	9		RESISTOR 10K 1% .125W F TC=0/+100	24546	C4=1/8-T0=1002-F
A15R33	0698-3454	3		RESISTOR 215K 1% .125W F TC=0/+100	24546	C4=1/8-T0=2153-F
A15R34	2100-2517	4	1	RESISTOR-TRMR 50K 10% C SIDE=ADJ 1-TRN	30983	E750X503
A15R35	0757-0463	4	1	RESISTOR 82.5K 1% .125W F TC=0/+100	24546	C4=1/8-T0=8252-F
A15U1	1820-0201	4	2	IC OP AMP GP TO=99	04713	MC1439G
A15U2	1820-0201	4	2	IC OP AMP GP TO=99	04713	MC1439G

See introduction to this section for ordering information
 *Indicates factory selected value

Table 6-2. REPLACEABLE PARTS

Reference Designation	HP Part Number	C D	Qty	Description	Mfr Code	Mfr Part Number
C1	0180-0198	9	2	CAPACITOR-FXD 1500UF+100-10% 50VDC AL	28480	0180-0198
C2	0180-0198	9		CAPACITOR-FXD 1500UF+100-10% 50VDC AL	28480	0180-0198
C3	0160-0168	1	1	CAPACITOR-FXD .1UF +-10% 200VDC POLYE	28480	0160-0168
C4	0180-0291	3	1	CAPACITOR-FXD 1UF+-10% 35VDC YA	56289	1500103X9039A2
CR1	1901-0033	2	1	DIODE-GEN PRP 180V 200MA DO-7	28480	1901-0033
CR2	1902-1225	8	1	DIODE-ZNR 1N2971RA 7.5V 10% DO-4 PD=10W	12954	1N2971RA
F1	2110-0421	6	1	FUSE .375A 250V 1.25X.25 UL (FOR 230V OPERATION)	75915	313.375
F1	2110-0360	2	1	FUSE .75A 250V 1.25X.25 UL (FOR 115V OPERATION) (OPT. 012)	75915	313.750
F2	2110-0312	4	1	FUSE 1A 250V 1.25X.25 UL (OPT 012 ONLY)	71400	MDL=1,
FL1	9100-3115	7	1	FILTER-LINE CEE=22*TERMS	28480	9100-3115
FL1	9100-2789	9	1	FILTER-LINE (OPT. 012 ONLY)	28480	9100-2789
J1	1250-0102	5	7	CONNECTOR-RF BNC FEM SGL-HOLE-FR 50-OHM	28480	1250-0102
J2	1250-0083	1	6	CONNECTOR-RF BNC FEM SGL-HOLE-FR 50-OHM	28480	1250-0083
J3	1250-0083	1		CONNECTOR-RF BNC FEM SGL-HOLE-FR 50-OHM	28480	1250-0083
J4	1250-0083	1		CONNECTOR-RF BNC FEM SGL-HOLE-FR 50-OHM	28480	1250-0083
J5	1250-0102	5		CONNECTOR-RF BNC FEM SGL-HOLE-FR 50-OHM	28480	1250-0102
J6	1250-0083	1		CONNECTOR-RF BNC FEM SGL-HOLE-FR 50-OHM	28480	1250-0083
J7	1250-0083	1		CONNECTOR-RF BNC FEM SGL-HOLE-FR 50-OHM	28480	1250-0083
J8	1250-0102	5		CONNECTOR-RF BNC FEM SGL-HOLE-FR 50-OHM	28480	1250-0102
J9	1250-0083	1		CONNECTOR-RF BNC FEM SGL-HOLE-FR 50-OHM	28480	1250-0083
J10	1250-0102	5		CONNECTOR-RF BNC FEM SGL-HOLE-FR 50-OHM	28480	1250-0102
J11	1250-0102	5		CONNECTOR-RF BNC FEM SGL-HOLE-FR 50-OHM (OPT 004 ONLY)	28480	1250-0102
J12	1250-0102	5		CONNECTOR-RF BNC FEM SGL-HOLE-FR 50-OHM (OPT 007 ONLY)	28480	1250-0102
J13	1250-0102	5		CONNECTOR-RF BNC FEM SGL-HOLE-FR 50-OHM (OPT 007 ONLY)	28480	1250-0102
M1	1120-1483	2	1	METER 2.25-IN; 100UA FSD; LINEAR; PIVOT	28480	1120-1483
M1	1120-1515	1	1	METER METER, 100 UA (OPT 008, 009, AND 010 ONLY)	28480	1120-1515
Q1	1854-0063	7	1	TRANSISTOR NPN 2N3055 SI TO-3 PDR115W	01928	2N3055
	1200-0043	8	1	INSULATOR-XSTR ALUMINUM	28480	1200-0043
Q2	1853-0052	2	1	TRANSISTOR PNP 2N3740 SI TO-66 PDR25W	04713	2N3740
	0340-0162	7	2	INSULATOR-XSTR ALUMINUM	28480	0340-0162
Q3	1854-0237	7	1	TRANSISTOR NPN SI TO-66 PDR20W FT=10MHZ	28480	1854-0237
	0340-0162	7		INSULATOR-XSTR ALUMINUM	28480	0340-0162
R1	2100-2652	8	1	RESISTOR-VAR CONTROL C 20 20% LIN	28480	2100-2652
R2	2100-2352	5	1	RESISTOR-VAR CONTROL C 1K 10% LIN	28480	2100-2352
R3	2100-1831	3	1	RESISTOR-VAR CONTROL CCP 100 10% LIN	28480	2100-1831
R4	2100-2651	7	1	RESISTOR-VAR CONTROL CCP 500K 20% LIN	28480	2100-2651
R5				NOT ASSIGNED		
R6				NOT ASSIGNED		
R7	0757-0416	7	1	RESISTOR 511 1% .125W F TC=0+100	24546	C4=1/8-T0=511R-F
R8	2100-2335	4	1	RESISTOR-VAR PREC MW 10-TRN 1K 3%	28480	2100-2335
R9	0698-3430	5	1	RESISTOR 21.5 1% .125W F TC=0+100	03888	PME59=1/8-T0=21R5-F
R10				NOT ASSIGNED		
R11	0698-3162	0	1	RESISTOR 46.4K 1% .125W F TC=0+100	24546	C4=1/8-T0=4642-F
R12	0698-3160	8	1	RESISTOR 31.6K 1% .125W F TC=0+100	24546	C4=1/8-T0=3162-F
R12	0698-3451	0	1	RESISTOR 133K 1% .125W F TC=0+100 (OPT 006 ONLY)	24546	C4=1/8-T0=1333-F
R12						
R13	0683-5145	2	1	RESISTOR 510K 5% .25W FC TC=800/+900 (OPT 001, 011, AND 012 ONLY)	01121	C85145
R14	2100-1904	1	1	RESISTOR-VAR CONTROL CC 10K 20% LIN (OPT 001, 002 AND 011 ONLY)	28480	2100-1904
R15	0686-4725	8	1	RESISTOR 4.7K 5% .5W CC TC=0+647 (OPT 001, 002 ONLY)	01121	E84725
S1	3100-2485	6	1	SWITCH-ROTARY LEVER 1.250 MTG CTR SPCG	28480	3100-2485
	0370-0432	7	5	KNOB LEVER SWITCH .200 X .220 X .375IN	28480	0370-0432
S2	3100-2028	3	1	SWITCH-ROTARY 1.250 STRUT CTR SPCG; 2	28480	3100-2028
	0370-0432	7		KNOB LEVER SWITCH .200 X .220 X .375IN	28480	0370-0432
S3	3101-0044	1	1	SWITCH-PB 8PST-NO MOM .5A 115VAC RED-BTN	28480	3101-0044
S4	3100-2055	6	3	SWITCH-ROTARY LEVER 1.250 MTG CTR SPCG	28480	3100-2055
	0370-0432	7		KNOB LEVER SWITCH .200 X .220 X .375IN	28480	0370-0432
S5	3100-2055	6		SWITCH-ROTARY LEVER 1.250 MTG CTR SPCG	28480	3100-2055
	0370-0432	7		KNOB LEVER SWITCH .200 X .220 X .375IN	28480	0370-0432
S6	3100-2055	6		SWITCH-ROTARY LEVER 1.250 MTG CTR SPCG	28480	3100-2055
	0370-0432	7		KNOB LEVER SWITCH .200 X .220 X .375IN	28480	0370-0432

See introduction to this section for ordering information
 *Indicates factory selected value

Table 6-2. REPLACEABLE PARTS

Reference Designation	HP Part Number	C D	Qty	Description	Mfr Code	Mfr Part Number
B7	3101-1957	7	1	SWITCH=PE DPST=NO ALING 10 5A 250VAC	28480	3101-1957
B8	2140-0244	4	1	LAMP=GLOW A1H 135/105VDC 1.2MA T=2=BULB	00466	A1H
	3101-1234	3	1	SWITCH=SL DPDT STD 1.5A 250VAC SLDR=LUG (AC LINE)	28480	3101-1234
B9	3101-1081	8	2	SWITCH=SENS SPDT SUBMIN .5A 30VDC	28480	3101-1081
	3101-1081	8	2	SWITCH=SENS SPDT SUBMIN .5A 30VDC	28480	3101-1081
B10	3101-0011	2	1	SWITCH=SL DPDT STD .5A 125VAC/DC	28480	3101-0011
B11	3101-1205	8	1	SWITCH=SENS DPDT=DB SUBMIN 10A 28VDC (OPT 001, 002, 011, AND 012 ONLY)	28480	3101-1205
B11	3101-1206	9	1	ACTUATOR=SW FL=LF (OPT 001, 002, 011, AND 012 ONLY)	28480	3101-1206
B11	08601-2047	3	1	PUSHBUTTON (MOD)	28480	08601-2047
	08601-2054	8	1	KNOB (MOD)	28480	08601-2054
T1	9100-2731	1	1	TRANSFORMER=POWER 115/230V 50=440HZ	28480	9100-2731
W1	8120-1348	5	1	CABLE ASSY 18AWG 3=CONDUCT BLK=JKT	28480	8120-1348
W1	08601-60096	9	1	CABLE ASSEMBLY=POWER (OPT. 012 ONLY)	28480	08601-60096
W2	08601-6039	0	1	CABLE ASSEMBLY=GRAY (VTO/LOOP AMPLIFIER)	28480	08601-6039
W3	08601-6037	6	3	CABLE=BLUE (VTO/VTO=BNC JACK)	28480	08601-6037
W4	08601-6029	9	3	CABLE=BLACK (VTO/XTAL OSC.)	28480	08601-6029
W5	08601-6032	6	1	CABLE=GREEN (DISC./VTO TV)	28480	08601-6032
W6	08601-6031	4	1	CABLE=RED (LPP/VIDEO AMPL)	28480	08601-6031
W7	08601-6030	2	1	CABLE=BROWN (XTAL OSC/LOOP AMPL)	28480	08601-6030
W8	08601-6038	8	1	CABLE=VIOLET (LOOP AMPL/UNCAL BNC JACK)	28480	08601-6038
W9	08601-6029	9	1	CABLE=BLACK (LOOP AMPL/DIV.)	28480	08601-6029
W10	08601-6029	9	1	CABLE=BLACK (DIV./DISC.)	28480	08601-6029
W11	08601-6036	4	1	CABLE=WHITE (ATTEN/RF OUT JACK)	28480	08601-6036
W11	08601-6054	2	1	OUTPUT CABLE=BNC 75 OHM (OPT 008 ONLY)	28480	08601-6054
W11	08601-6055	4	1	OUTPUT CABLE=TNC 75 OHM (OPT 009 ONLY)	28480	08601-6055
W11	08601-6056	6	1	OUTPUT CABLE=NE 75 OHM (OPT 01 ONLY)	28480	08601-6056
W12	08601-6037	6	1	CABLE=BLUE (DIV./AUX OUT)	28480	08601-6037
W13	08601-6037	6	1	CABLE=BLUE (DIV./AUX OUT) OPT 004 ONLY	28480	08601-6037
W14	08601-6052	8	1	CABLE=YELLOW (LO INPUT/BB AMPL.)	28480	08601-6052
W15	08601-6078	2	1	CABLE=WHITE (VTO OUT/VTO) OPT 007 ONLY	28480	08601-6078
W16	08601-6034	0	1	CABLE=ORANGE (AM OUT/XTAL OSC) OPT 007 ONLY	28480	08601-6034
W17	08601-6033	8	1	CABLE=YELLOW (ALC SIG/FREQ CONT)	28480	08601-6033
W18	08601-6035	2	1	CABLE=GRAY (SW/DISC.)	28480	08601-6035
W19	10502-6001	6	1	CABLE=GRAY (VTO OUT/LO INPUT)	28480	10502-6001
W20	11592-60013	5	1	CABLE ASSEMBLY (OPT. 007)	28480	11592-60013
W21	8120-2582	1	1	CABLE 188Y=COAX 50=OHM 4=IN=LG JGK (OPT 012 ONLY)	28480	8120-2582
MISCELLANEOUS PARTS						
	0360-0042	4	1	TERMINAL=SLDR LUG PL=MTG FOR=46=8CR	28480	0360-0042
	1200-0768	4	1	SOCKET=IC 14=CONT DIP=SLDR	28480	1200-0768
	1250-0838	4	1	ADAPTER=COAX TEE F=8MC M=8MC (OPT 004 ONLY)	28480	1250-0838
	1490-0849	5	1	BRACKET=RTANG .6=LG X .64=LG .31=WD STL	28480	1490-0849
	2190-0007	2	1	WASHER=LK INTL T NO. 6 .141=IN=ID	28480	2190-0007
	2360-0195	0	1	SCREEN=MACH 6=32 .312=IN=LG PAN=MD=POZI	00000	ORDER BY DESCRIPTION
	2420-0001	5	1	NUT=HEX=H/LKWR 6=32=THD .109=IN=THK	00000	ORDER BY DESCRIPTION
	5040-0170	6	2	GUIDEPLUG=IN PC BOARD (OPT 001, 002, 011 AND 012 ONLY)	28480	5040-0170
	8160-0084	8	1	RPI ROUND STRIP NI=ALY .125=IN=OD	28480	8160-0084
	08601-0014	2	1	BRACKET=PD (OPT. 007 ONLY)	28480	08601-0014
	08698-0012	3	1	GASKET=RFI	28480	08698-0012
FRONT PANEL						
	0370-0134	6	1	KNOB .500 IN ODI .125 IN DIA SHAFT=RED	28480	0370-0134
	0370-0487	2	1	KNOB=1.250 IN ODI .250 IN DIA SHAFT	28480	0370-0487
	0370-0125	5	1	KNOB .500 IN ODI .125 IN DIA SHAFT	28480	0370-0125
	0370-0149	3	1	KNOB=CRANK 1.625 IN ODI .250 IN DIA	28480	0370-0149

See introduction to this section for ordering information
*Indicates factory selected value

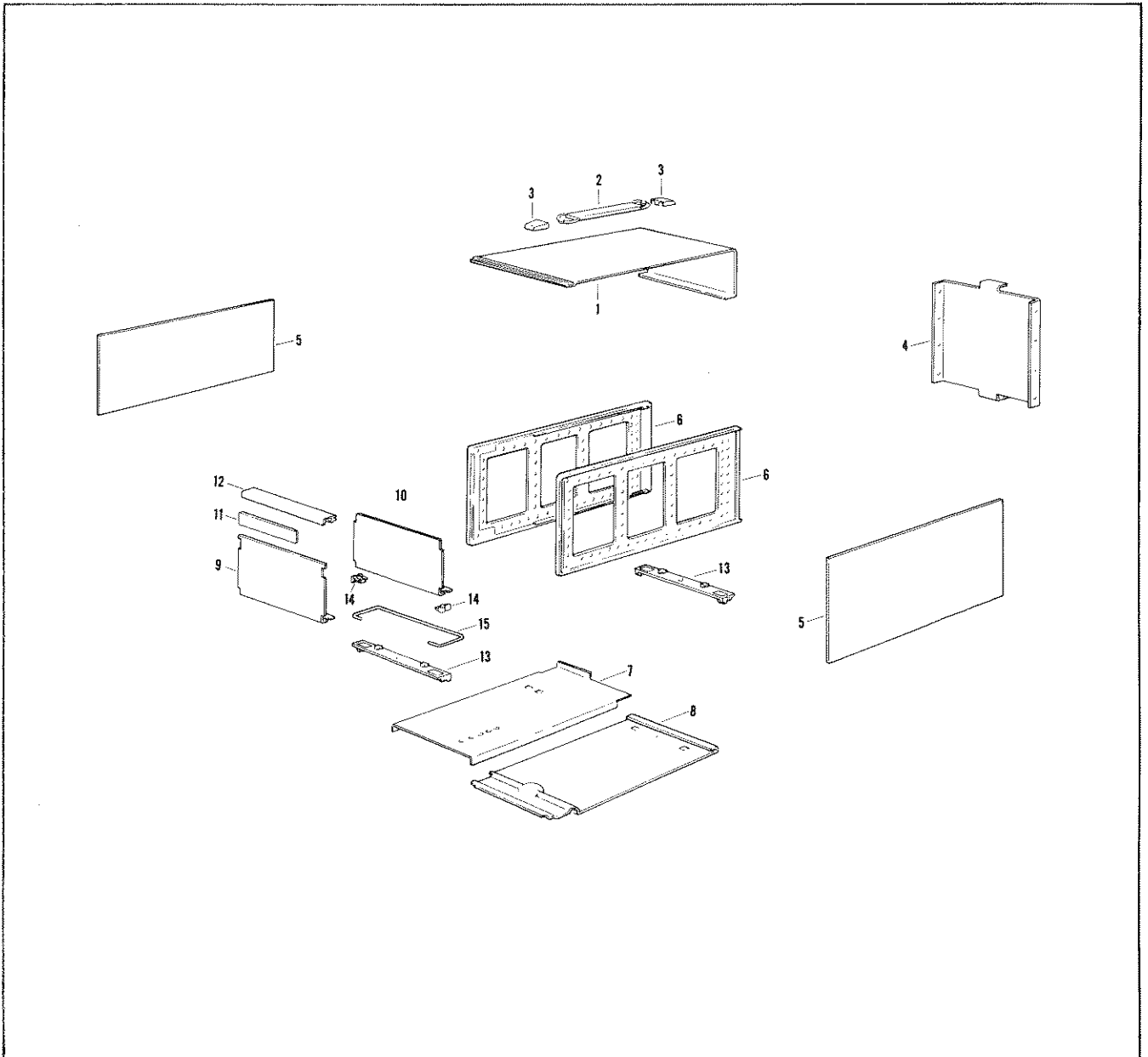

Reference Designation	HP Part Number	C D	Qty	Description	Mfr Code	Mfr Part Number
				CABINET PARTS		
1	08601-00044	1	1	COVER-TOP	28480	08601-00044
2	1440-0076	5	1	HANDLE-PCLYP 7.95=LG	28480	1440-0076
3	1440-0077	6	1	RETAINER-HANDLE STL	28480	1440-0077
4	08601-00032	7	1	PANEL-REAR	28480	08601-00032
5	5000-8567	7	1	COVER-SIDE	28480	5000-8567
6	5060-0704	4	2	FRAME ASSEMBLY- 6 X 16 SM	28480	5060-0704
7	08601-0001	5	1	DECK-MAIN	28480	08601-0001
8	5000-8535	9	1	COVER ASSEMBLY-BOTTOM	28480	5000-8535
9	08601-00043	0	1	PANEL-FRONT	28480	08601-00043
10	08601-0003	9	1	PANEL-SUB	28480	08601-0003
11	08601-20089	6	1	PANEL-READOUT	28480	08601-20089
12	08601-20091	0	1	METER TRIM-TOP	28480	08601-20091
13	5060-0728	2	2	FOOT ASSEMBLY HALF MODULE	28480	5060-0728
14	5040-0700	8	2	HINGE	28480	5040-0700
15	1490-0032	8	1	TILT STAND 2.236-IN=W 7.088-IN=QA=LG SST	28480	1490-0032

Figure 6-2. Cabinet Parts

Table 6-2. REPLACEABLE PARTS

Reference Designation	HP Part Number	C D	Qty	Description	Mfr Code	Mfr Part Number
	4040-0905	4	1	BEZEL:METER WINDOW(STD)OLIVE BLACK	28480	4040-0905
	08601-2009	3	1	ADAPTER=BHAFT	28480	08601-2009
	08601-00043	0	1	PANEL=FRONT	28480	08601-00043
	08601-00046	3	1	(OPT 001,002)	28480	08601-00046
	08601-00045	2	1	PANEL=FRONT (OPT 011)	28480	08601-00045
	08601-00050	9	1	NAMEPLATE=400HZ MOD (OPT. 005 ONLY)	28480	08601-00050
				REAR PANEL MISCELLANEOUS		
	2110-0470	5	1	FUSEHOLDER BODY EXTR PBT; BAYONET; TND	79915	345003-010
	2110-0465	8	1	FUSEHOLDER CAP EXTR PBT; BAYONET; 20A	28480	2110-0465
	6960-0002	4	1	PLUG=HOLE DOME=MD FOR .5=D-HOLE STL	28480	6960-0002
	08601-00032	7	1	PANEL=REAR	28480	08601-00032
	1250-0053	5	8	CAP=COAX TO FIT F=BNC NON=SMTG 2.5=CH	28480	1250-0053
	5020-0701	7	3	CABINET SPACER	28480	5020-0701
	08601-60107	3	1	PANEL=FRONT (OPT 012 ONLY)	28480	08601-60107
	08601-00035	0	1	BRACKET=ATTEN MTG (OPTION 012 ONLY)	28480	08601-00035
	08601-00036	1	1	BRACKET=TRANSFORMER MTG. (OPT. 012 ONLY)	28480	08601-00036
	08601-00037	2	1	PANEL=REAR (OPT. 012 ONLY)	28480	08601-00037
	08601-00038	3	1	COVER=TOP (OPT. 012 ONLY)	28480	08601-00038
	08601-00039	4	1	COVER=BOTTOM (OPT. 012 ONLY)	28480	08601-00039
	08601-00040	7	2	COVER=SIDE (OPT. 012 ONLY)	28480	08601-00040
	08601-20067	4	1	GUIDE=BOARD (OPT. 012 ONLY)	28480	08601-20067
	08601-20068	5	1	BAR=BRACE (OPT. 012 ONLY)	28480	08601-20068
	08601-20093	2	1	TRIM=METER (OPT. 012 ONLY)	28480	08601-20093
	08601-60106	2	1	CABLE ASSEMBLY=RF (OPT. 012 ONLY)	28480	08601-60106

See introduction to this section for ordering information
 *Indicates factory selected value

Table 6-3. Code List of Manufacturers

MFR NO.	MANUFACTURER NAME	ADDRESS	ZIP CODE
0000J	GTE SYLVANIA MINIATURE LT PROD	HILLSBORO NH	03244
00000	ANY SATISFACTORY SUPPLIER		
00466	NORELCO NORTH AMER PHILIPS LIG CORP	LOS ANGELES CA	90021
0090R	KEMET		
01121	ALLEN-BRADLEY CO	MILWAUKEE WI	53204
01295	TEXAS INSTR INC SEMICOND CMPNT DIV	DALLAS TX	75222
0192B	RCA CORP SOLID STATE DIV	SOMERVILLE NJ	08876
02114	FERROXOCUBE CORP	SAUGERTIES NY	12477
0388R	KOI PYROFILM CORP	WHIPPANY NJ	07961
04713	MOTOROLA SEMICONDUCTOR PRODUCTS	PHOENIX AZ	85062
06001	GE CO ELEK CAP & BAT PROD DEPT	IRMO SC	29063
07263	FAIRCHILD SEMICONDUCTOR DIV	MOUNTAIN VIEW CA	94042
12954	SIEMENS CORP COMPONENTS GROUP	SCOTTSDALE AZ	85252
18911	DURANT DIGITAL INSTRUMENTS	MILWAUKEE WI	53201
19701	MEPCO/ELECTRA CORP	MINERAL WELLS TX	76067
24546	CORNING GLASS WORKS (BRADFORD)	BRADFORD PA	16701
28480	HEWLETT-PACKARD CO CORPORATE HQ	PALO ALTO CA	94304
30983	MEPCO/ELECTRA CORP	SAN DIEGO CA	92121
33095	SPECTRUM CONTROL INC	FAIRVIEW PA	16415
51642	CENTRE ENGINEERING INC	STATE COLLEGE PA	16801
56289	SPRAGUE ELECTRIC CO	NORTH ADAMS MA	01247
71041	BOSTON GEAR WKS DIV OF NA ROCKWELL	QUINCY MA	02171
71400	BUSSMAN MFG DIV OF MCGRAW-EDISON CO	ST LOUIS MO	63107
72136	ELECTRO MOTIVE CORP SUB IEC	WILLIMANTIC CT	06226
72982	ERIE TECHNOLOGICAL PRODUCTS INC	ERIE PA	16512
7313R	BECKMAN INSTRUMENTS INC HELIPOT DIV	FULLERTON CA	92634
74970	JOHNSON E F CO	WASECA MN	56093
75042	TRW INC PHILADELPHIA DIV	PHILADELPHIA PA	19108
75915	LITTELFUSE INC	DES PLAINES IL	60016
84411	TRW CAPACITOR DIV	UGALLALA NE	69153
87470	NO M/F DESCRIPTION FOR THIS MFG NUMBER		

SECTION VII MANUAL CHANGES

7-1. INTRODUCTION

7-2. This manual includes information that applies directly to HP Model 8601A instruments serial prefixed 969-. To adapt this manual to instruments with serial numbers prefixed 959-, 954-, 945-, 912-, 839-, 838-, 828-, 826-, or 818-, make the necessary changes listed in Table 7-1. A summary of the circuit assembly components or assemblies affected is given in Table 7-2.

NOTE

Some changes are already shown or noted in the schematic section. If differences are detailed on the schematic diagram, the serial prefix numbers are given in the schematic notes.

7-3. Information for adapting this manual to instruments with serial number prefixes greater than 969- is given in a Manual Changes sheet, included with this manual.

Table 7-1. Change Information for Serial Prefixes 818- thru 1843A.

Serial Prefix or Number	Make Manual Changes*	Serial Prefix or Number	Make Manual Changes
959-	1	0969A02216 thru 02355	14 thru 34
954-	1, 2	0969A02356 thru 02565	15 thru 34
945-	1 thru 3	1144A02566 thru 02810	16 thru 34
912-00881 thru -01030	1 thru 4	1144A02811 thru 02845	17 thru 34
912-05531 thru -00880	1 thru 5	1144A02846 thru 02985	18 thru 34
912-00531 thru -00580	1 thru 6	1144A02986 thru 03055	19 thru 34
839-00530, -00529 -00527, -00523 -00496, -00468 -00467	1 thru 7	1144A03056 thru 03300	20 thru 34
839-00460 thru -00462		1144A03301 thru 03545	21 thru 34
839-00528 839-00524 thru -00526 839-00497 thru -00522 839-00469 thru -00495 839-00463 thru -00466 839-00381 thru -00459	1 thru 8	1144A03546 thru 04245	22 thru 34
839-00331 thru -00380	1 thru 9	1144A04246 thru 04630	23 thru 34
838-	10	1512A04631 thru 04630	24 thru 34
828-	10, 11	1512A04736 thru 04910	25 thru 34
826-	10 thru 12	1512A04911 thru 05155	26 thru 34
818-	10 thru 13	1512A05156 thru 1512A prefix	27 thru 34
		1612A	28 thru 34
		1707A	29 thru 34
		1728A	30 thru 34
		1752A	31 thru 34
		1804A	32 thru 34
		1813A	33 thru 34
		1843A	34
*and changes 14-34			

Table 7-2. Changes Summary (1 of 2)

Change	Assembly (s) Affected													No Prefix
	A1 Assy	A2 Assy	A2 Assy	A4 Assy	A5 Assy	A6 Assy	A7 Assy	A8 Assy	A9 Assy	A10 Assy	A11 Assy	A12 Assy	A13 Assy	
1	A1C14 A1C15													FL1, F1, S7, S8, W1
2	A1L5													
3	A1R16 A1R19 A1R12		A1						Q11/42 R3/18/19 R173/124			C2 (wiring)		R5/6/10 C4
4														R2 Bracket
5					Module Box									
6										CR14				
7	A1C7 A1R1-2	A1C27 A1C28 A1C29	A1C17	A1R9-10 A1R12-13						R10 R12				
8	A1C5 A1C10 A1L1 A1R19 A1R22 A1R30													
9														Q3
10	A1	A1	A2	A1	A1				Q17/18 R11/23 R157/165					FL1 S10 and specifications
11						A1R6			R180 C14					
12	A1R8 A1R2	A1C8	A2	A1R2 A1C14/C34										
13			A1R20	A1Q6	A1				R169 R134 R181					
14									E1					
15									C11					

Table 7-2. Changes Summary (2 of 2)

Changes	Assembly(s) Affected													
	A1 Assy	A2 Assy	A3 Assy	A4 Assy	A5 Assy	A6 Assy	A7 Assy	A8 Assy	A9 Assy	A10 Assy	A11 Assy	A12 Assy	A13 Assy	No. Prefix
16														outside panels color change
17				A1R7										
18								R3						
19				A1Q1+3 A1Q12										
20								R144						
21										R7				
22				A1R14										
23									R120					
24														specifications
25							MPI				S1			
26										R32				
27												C1		
28														
29								E1						
30									R178	A30				S7, Fuseholder
31									C41, R24, 34, 88, 95, 117, 130, 136, 160, 162, 181					F1
32								F1						
33														
34														
35														R11

CHANGE 1

Schematic Sheet 2; Divider, Divider Bypass A2:
Delete capacitors A2A1C14 and A2A1C15, replace with open circuit.

Schematic Sheet 8, Power Supply:
AC Primary circuit is as shown in Figure 7-1.

Table 6-2, Replaceable Parts:

Change fuse F1 (115V) to HP Part No. 2110-0007.

Change fuse F1 (230V) to HP Part No. 2110-0008.

Change line filter FL1 to HP Part No. 9100-2821. The ac receptacle is an integral part of the filter unit.

Change switch S7 to HP Part No. 3101-0100.

Change switch S8 to HP Part No. 3101-0033.

Change power cable W1 to HP Part No. 8120-0078.

Change rear panel to HP Part No. 08601-00033.

CHANGE 2

Schematic Sheet 2; Divider, Divider Bypass, A2:
Delete inductor A2A1L5, replace with short circuit (see Operation discussion opposite schematic).

CHANGE 3

Schematic Sheet 1; A1 Discriminator Assembly:
Schematic Diagram is changed as shown in Figure 7-3. Component identification photo is as shown in Figure 7-2.

Schematic Sheet 2; A2 Divider Assembly:

Delete resistor A2A1R19.

Connect resistor A2A1R16, 100 ohms, between A2J2 and ground.

Connect resistor A2A1R12, 33 ohms, in parallel with A2A1C8.

Schematic Sheet 4, A4 Crystal Oscillator Assembly:

Schematic diagram is changed as shown in Figure 7-4. Component identification photo is as shown in Figure 7-5.

Schematic Sheet 9:

Delete A9Q11, A9R185, A9R184, and SWEEP INHIBIT input connector.

Change A9C1 to 1.5 μ F.

Replace A9CR31 with short circuit.

Change A9R3 to 23.7K and A9R2 to 9090 ohms.

Change A9C11 to 0.01 μ F.

Component identification photo is as shown in Figure 7-6.

Schematic Sheet 10:

Change A9R126 to 1000 and A9R123 to 4220.

Add A9R125, 1100 ohms, in parallel with A9R126.

Add A9R124, 100 ohm, in parallel with A9R123.

Component identification photo is as shown in Figure 7-7.

Add Sweep reference circuit as shown in Figure 7-8.

Schematic Sheet 12:

Add resistor R5, 34.8 ohm, in parallel with R3.

Add resistor R6, 5 ohm, in parallel with R1.

Change capacitor A12C2 to 60 μ F.

Change capacitor C4 to 0.33 μ F.

Table 6-2, Replaceable Parts:

Change capacitor A9C1 to HP Part No. 0180-1745 C:FXD 1.5 μ F 10% 35 VDCW.

Change capacitor A9C11 to HP Part No. 0150-0093 C:FXD CER 0.01 μ F +80 -20% 100 VDCW.

Change resistor A9R3 to HP Part No. 0698-3158 R:FXD MET FLM 23.7K ohm 1% 1/8W.
 Change resistor A9R18 to HP Part No. 0698-3460 R:FXD MET FLM 422K ohm 1% 1/8W.
 Change resistor A9R19 to HP Part No. 0698-3260 R:FXD MET FLM 464K ohm 1% 1/8W.
 Change resistor A9R173 to HP Part No. 0698-3434 R:FXD MET FLM 34.8 ohm 1% 1/8W.
 Change rear panel to HP Part No. 08601-00005.
 Change resistor A9R123 to HP Part No. 0698-3154 R:FXD MET FLM 4.22K ohm 1% 1/8W.
 Change resistor A9R126 to HP Part No. 0757-0159 R:FXD MET FLM 1K ohm 1% 1/2W.
 Change capacitor A12C2 to HP Part No. 0180-0106 C:FXD ELEC TA 60 μ F 20% 6 VDCW.
 Change capacitor C4 to HP Part No. 0160-0163 C:FXD MY 0.033 μ F 10% 200 VDCW.

CHANGE 4

The POWER LEVEL VERNIER potentiometer, R2, is attached (with machine-screw threads) to output attenuator body assembly.

CHANGE 5

Module box that houses A5 VTO assembly does not have side holes allowing adjustment access.

Table 6-2:

Change A5 HP Part No. to 08601-2016.

CHANGE 6

Schematic Sheet 8:

Replace A10CR14 with short circuit.

NOTE

Diode, A10CR14, prevents momentary -75 volt power supply shorts from damaging transistors A10Q6 and A10Q7. It is recommended that A10CR14 be added to all -75 volt power supplies.

CHANGE 7

Schematic Sheet 2, A2 Divider Assembly:

Add A2A1C7, 10 pF, in parallel with A2A1R9.

Change A2A1R1 to 61.9 ohm; also A2A1R2 to 261 ohm.

Schematic Sheet 3, A3 Loop Mixer Assembly:

Change A3A1C27 and A3A1C29 to 2000 pF.

Change A3A1C28 to 4.7 μ F.

Schematic Sheet 4, A4 Crystal Oscillator Assembly:

Circuitry is same as Figure 7-4 except capacitor A4A1C17 is 20 pF.

NOTE

In event of A4A1Q6 failure or replacement, change capacitor A4A1C17 to 24 pF.

Schematic Sheet 5, A5 Voltage Tuned Oscillator Assembly:

Change A5A1R9 to 1470 ohm, A5A1R10 to 26.1K ohm, A5A1R12 to 237K ohm, and A5A1R13 to 50K ohm.

Schematic Sheet 8, A10 Power Supply Assembly:

Change A10R10 to 19.6K ohm and A10R12 to 10K ohm.

Table 6-2, Replaceable Parts:

Add A2A1C7, HP Part No. 0160-2257 C:FXD CER 10 pF 5% 500 VDCW.

Change A2A1R1 to HP Part No. 0757-0276 R:FXD MET FLM 61.9 ohm 1% 1/8W.

Change A2A1R2 to HP Part No. 0698-3132 R:FXD MET FLM 261 ohm 1% 1/8W.

Change A3A1C27 and A3A1C29 to HP Part No. 0160-2143 C:FXD CER 2000 pF +80 -20% 1000 VDCW.

Change A3A1C28 to HP Part No. 0180-1735 C:FXD ELECT 4.7 μ F 10% 35 VDCW.
Change A5A1R9 to HP Part No. 0757-1094 R:FXD MET FLM 1.47K ohm 1% 1/8W.
Change A5A1R10 to HP Part No. 0698-3159 R:FXD MET FLM 26.1K ohm 1% 1/8W.
Change A5A1R12 to HP Part No. 0698-3266 R:FXD MET FLM 237K ohm 1% 1/8W.
Change A5A1R13 to HP Part No. 2100-2031 R:VAR CER MET 50K ohm 30% LIN 1/2W.
Change A10R10 to HP Part No. 0698-3157 R:FXD MET FLM 19.6K ohm 1% 1/8W.
Change A10R12 to HP Part No. 0757-0442 R:FXD MET FLM 10K ohm 1% 1/8W.

CHANGE 8

Schematic Sheet 1, A1 Discriminator Assembly:

Circuitry is as shown in Figure 7-3, except;

Change A1A1C5 to 0.47 μ F, A1A1C10 to 1000 pF, A1A1L1 to 200 μ H, A1A1R22 to 2150 ohm, A1A1R30 to 68.1K ohm, and A1A1R19 to 1780 ohms.

Table 6-2, Replaceable Parts:

Change A1A1R19 to HP Part No. 0757-0278 R:FXD MET FLM 1.78K ohm 1% 1/8W.

Change A1A1C5 to HP Part No. 0160-0174 C:FXD CER 0.47 μ F +80 -20% 25 VDCW.

Change A1A1C10 to HP Part No. 0160-0153 C:FXD MY 1000 pF 10% 200 VDCW.

Change A1A1L1 to HP Part No. 9140-0237 COIL:FXD RF 200 μ H.

Change A1A1R22 to factory selected component, HP Part No. 0698-0084 R:FXD MET FLM 2.15K ohm 1% 1/8W.

Change A1A1R30 to HP Part No. 0757-0461 R:FXD MET FLM 68.1K ohm 1% 1/8W.

CHANGE 9

Schematic Sheet 8:

Q3 is HP Part No. 1854-0253 which is a discontinued part. Recommended replacement is HP Part No. 1854-0237.

CHANGE 10

Schematic Sheet 1, A1 Discriminator Assembly:

Schematic diagram is changed as shown in Figure 7-10. Component identification photo is as shown in Figure 7-9.

Schematic Sheet 2, A2 Divider Assembly:

Schematic Diagram is changed as shown in Figure 7-12. Component identification photo is as shown in Figure 7-11. Replaceable parts information is given in Table 7-3.

Schematic Sheet 3, A3 Loop Mixer Assembly:

A3A2A1 Mixer Assembly is changed as shown in Figures 7-13 and 7-14.

Schematic Sheet 4, A4 Crystal Oscillator Assembly:

Schematic Diagram is changed as shown in Figure 7-16. Component identification photo is as shown in Figure 7-15. Replaceable parts information is given in Table 7-4.

Schematic Sheet 5, A5 VTO Assembly:

Schematic diagram is changed as shown in Figure 7-18. Component identification photo is as shown in Figure 7-17.

Table 1 1, Specifications:

The following specification changes are made:

Stability in CW: (0.01% +500 Hz) 10 min, high range, after one hour warm-up.
(0.01% +50 Hz)/10 min, low range, after one hour warm-up.

Sweep Width Accuracy: $\pm 5\%$ of sweep width or ± 10 kHz, high range, $\pm 5\%$ of sweep width or ± 1 kHz, low range, whichever is greater.

Internal FM:

High Range: 75 kHz $\pm 20\%$ peak deviation, 1 kHz range.

Low Range: 7.5 kHz $\pm 20\%$ peak deviation, 1 kHz rate.

Less than 3% distortion, typically less than 1%.

Schematic Sheet 9, A9 Assembly:
 Change A9Q18B to A9Q18, HP Part No. 1854-0071.
 Change A0Q18A to A9Q17, HP Part No. 1854-0071.
 Change A9R23 to 1470 ohms.
 Delete S10 (replace with short circuit).

Schematic Sheet 10, A9 Assembly:
 Change A9R111 to 14.6K ohms.

Schematic Sheet 11, A9 Assembly:
 Change A9R157 to 21.5K and A9R165 to 1000 ohms.
 Delete S10 (replace with short circuit).

Table 6-2, Replaceable Parts:
 Change A9Q18 and A9Q17 to HP Part No. 1854-0071.
 Change A9R23 to HP Part No. 0757-1094 R:FXD 1470 ohms.
 Change A9R111 to HP Part No. 0698-3156 R:FXD 14.6K
 Change A9R157 to HP Part No. 0757-0199 R:FXD 21.5K
 Change A9R165 to HP Part No. 0757-0280 R:FXD 1000 ohms.

CHANGE 11

Schematic Sheet 6, A6 Assembly:
 Delete A6A1R6 (replace with short circuit).

Schematic Sheet 9, A9 Assembly:
 Change A9R180 to 2870 ohms and A9C14 to 0.1 μ F.

Table 6-2, Replaceable Parts:
 Change A9R180 to HP Part No. 0698-3151 R:FXD 2870 ohms.
 Change A9C14 to HP Part No. 0180-1743 C:FXD 0.1 μ F.

CHANGE 12

Schematic Sheet 5, A5 VTO Assembly:
 Schematic diagram is as shown in Figure 7-14 with the following changes;
 A5A1R2 is 8.25K, HP Part No. 0757-0441.
 A5A1C14 and A5A1C34 are 10 pF, HP Part No. 0160-2257.

CHANGE 13

Schematic Sheet 6, A6 Assembly:
 Add capacitor C6, 1.5 pF and coil L3, 0.15 μ H in series between A6A1E1 case and ground.

Section V, paragraph 5-16:
 Change Meter Adjustment procedure as follows:

1. Connect power meter to 8601A RF OUTPUT.
2. Set 8601A controls as follows:

CW/SWEEP	CW	RANGE	110
		FREQUENCY	60 MHz
3. Set OUTPUT LEVEL to +10 dBm position and adjust OUTPUT LEVEL VERNIER for +10 dBm power meter reading.
4. Adjust METER adjust A9R131 for +10 dBm reading (0 dBm on scale).
5. Adjust OUTPUT LEVEL VERNIER for 0 dBm power meter reading.
6. Adjust meter mechanical adjustment for 0 dBm reading (-10 dBm on scale).
7. Repeat steps 3 through 6 until no further adjustment is required.

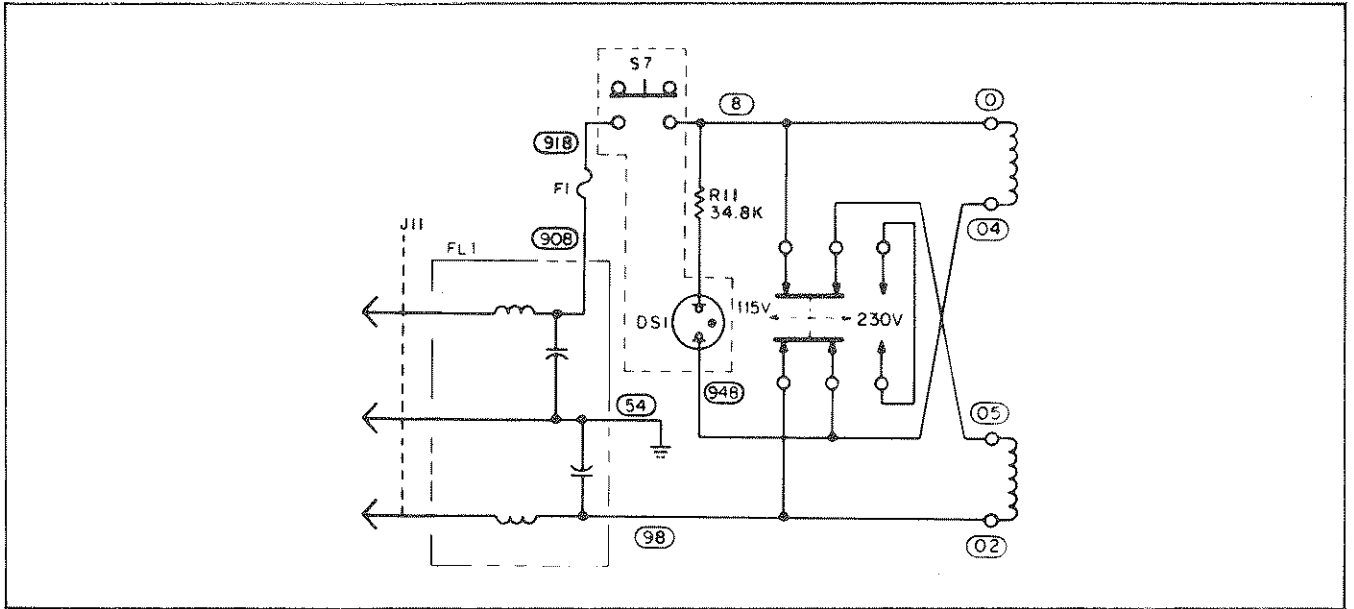

Figure 7-1. AC Primary Circuit
(Part of Change 1)

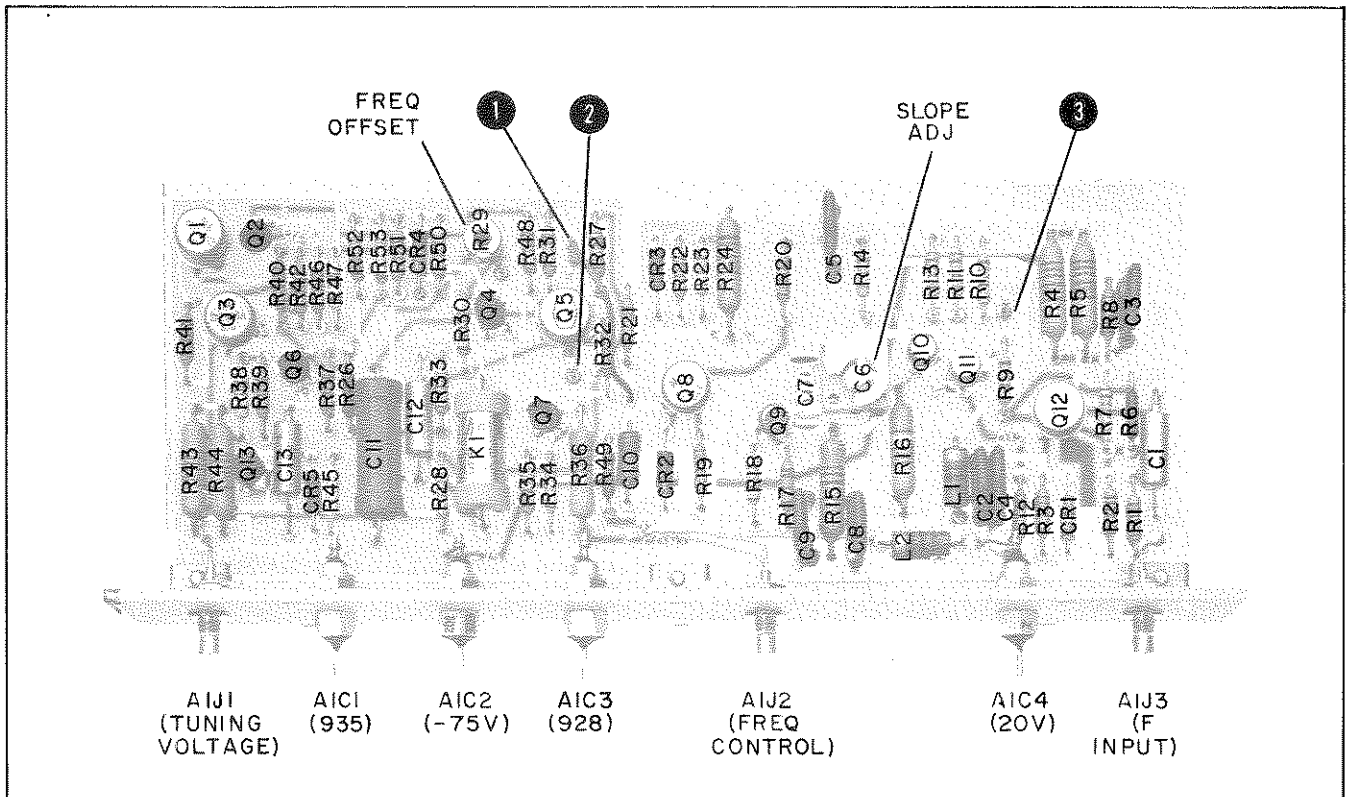

Figure 7-2. Component Identification A1A1 Discriminator Assembly
(Part of Change 3)

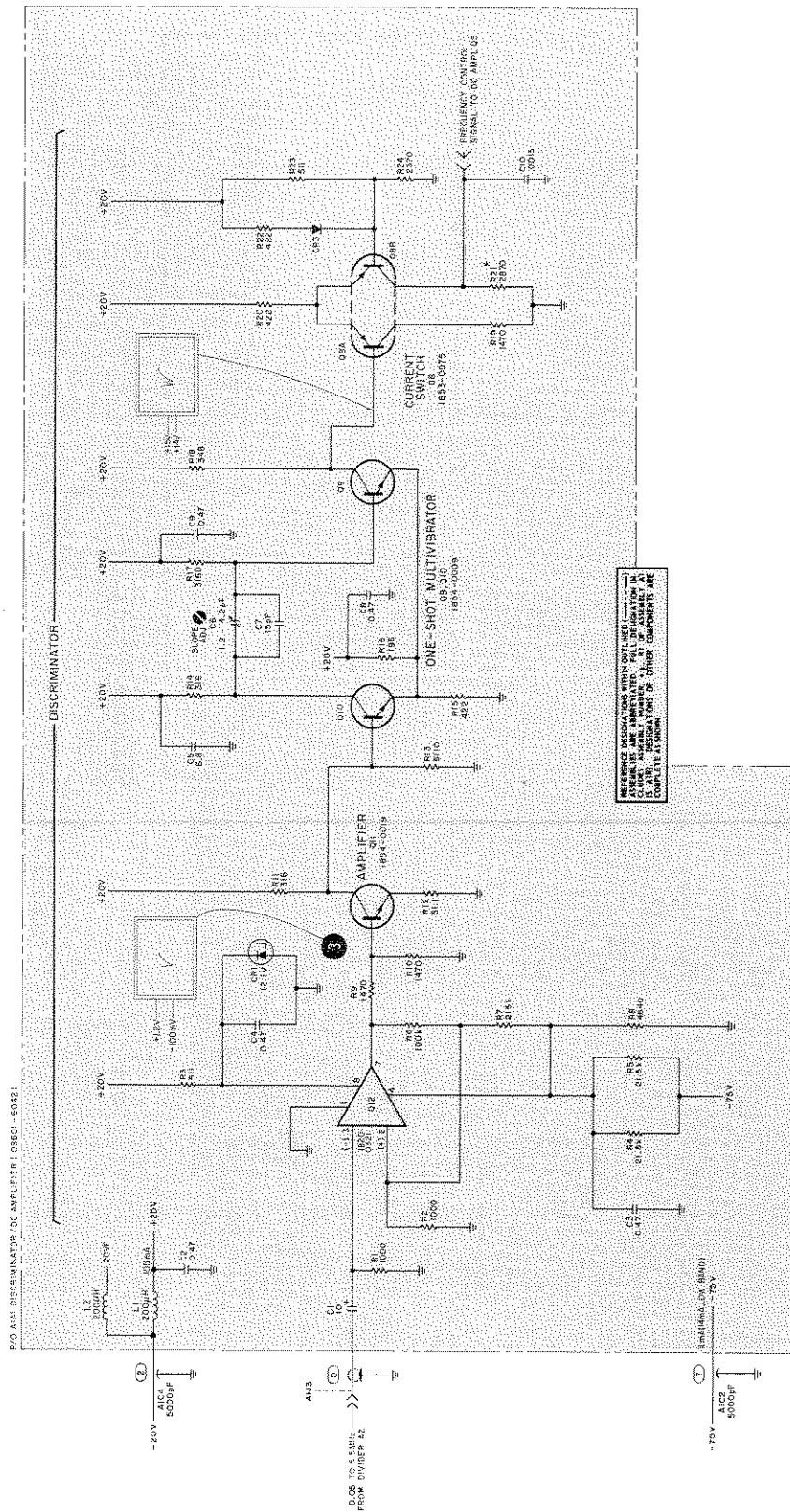

Figure 7-3. A1A1 Discriminator Circuit, Schematic Diagram (Part of Change 3)

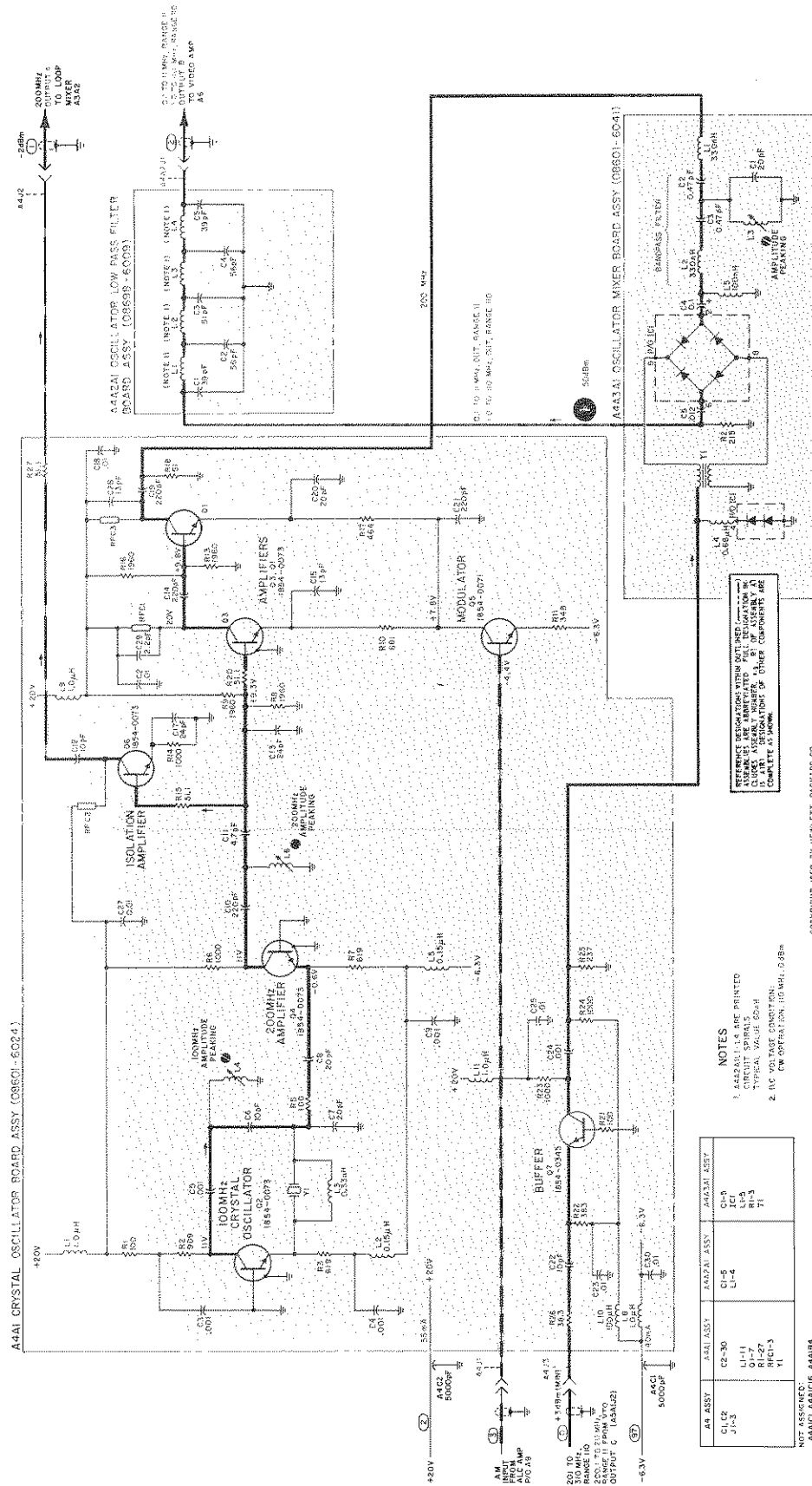

Figure 7-4. A4 Crystal Oscillator, Modulator, Oscillator Mixer, Oscillator Low Pass Filter, Schematic Diagram (Part of Change 3)

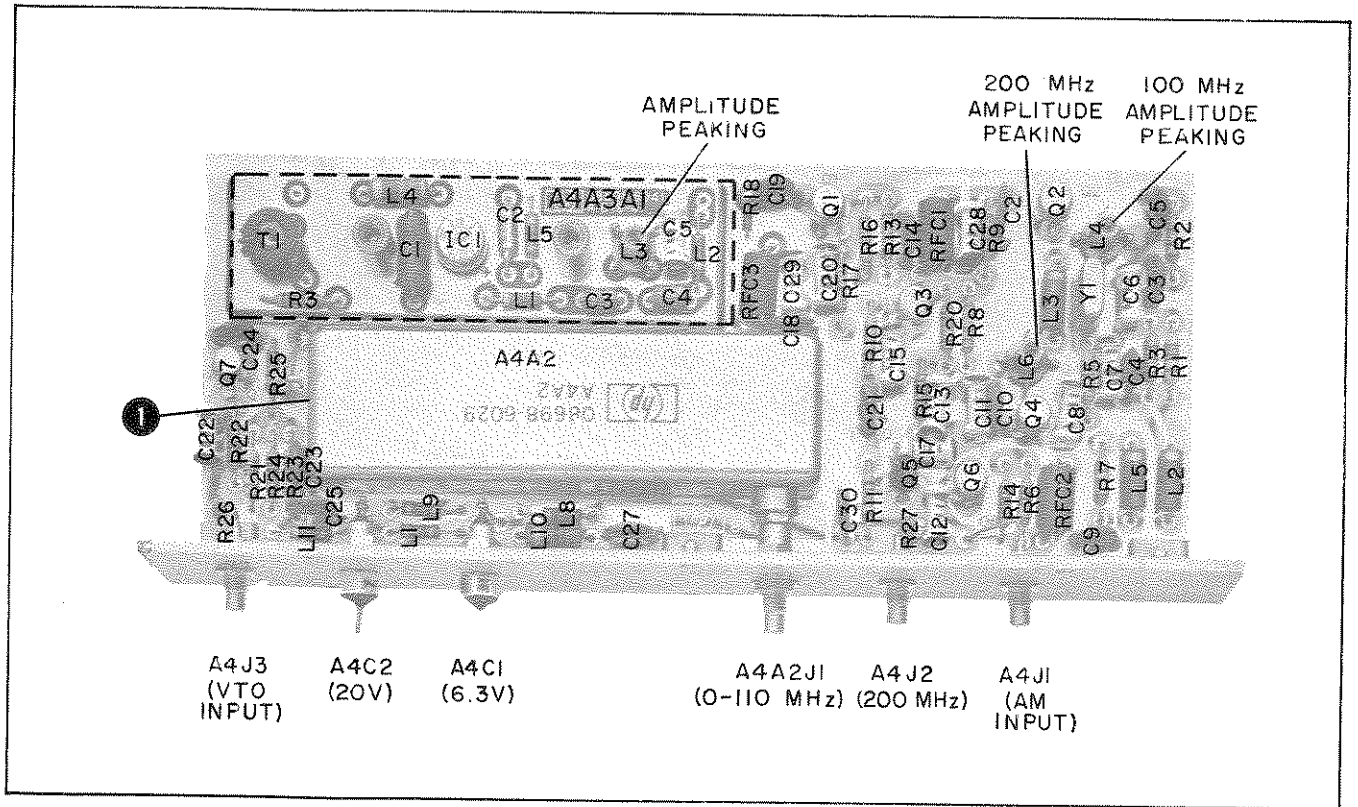

Figure 7-5. Component Identification, A4A1 Crystal Oscillator Assembly (Part of Change 3)

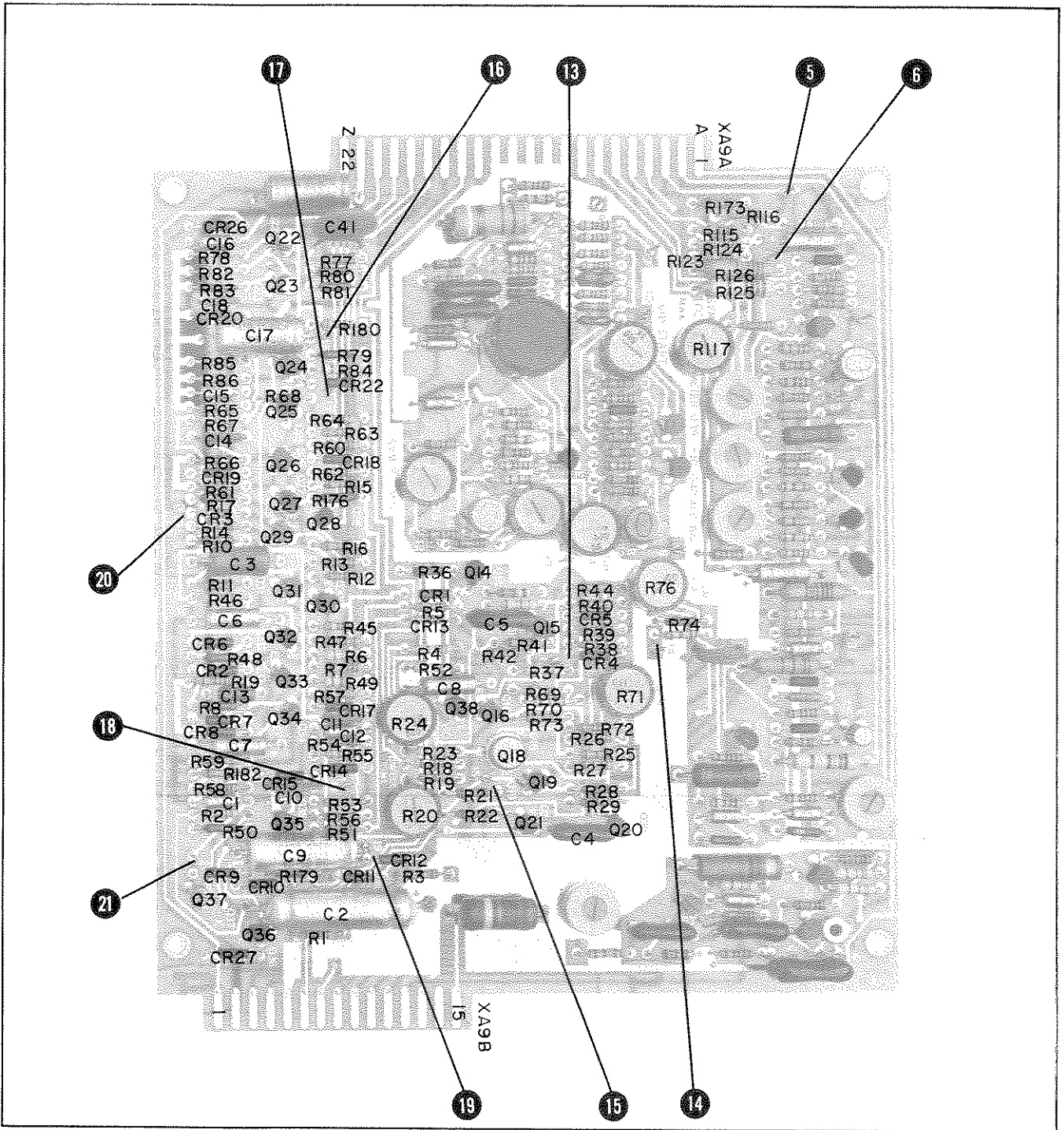

Figure 7-6. Component Identification, Sweep Generator, P/O A9
(Part of Change 3)

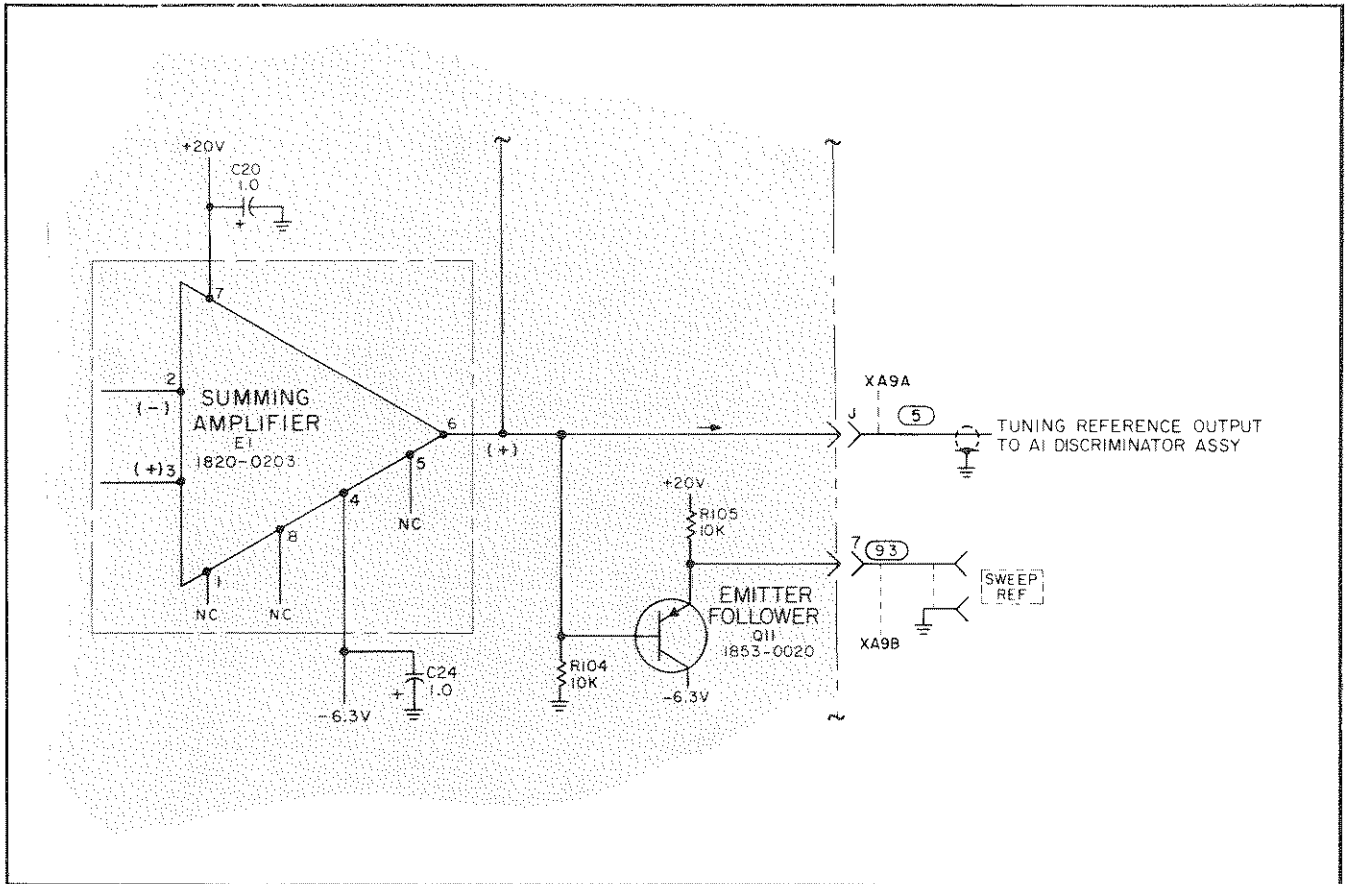

Figure 7-8. Sweep Reference Circuit, P/O A9
(Part of Change 3)

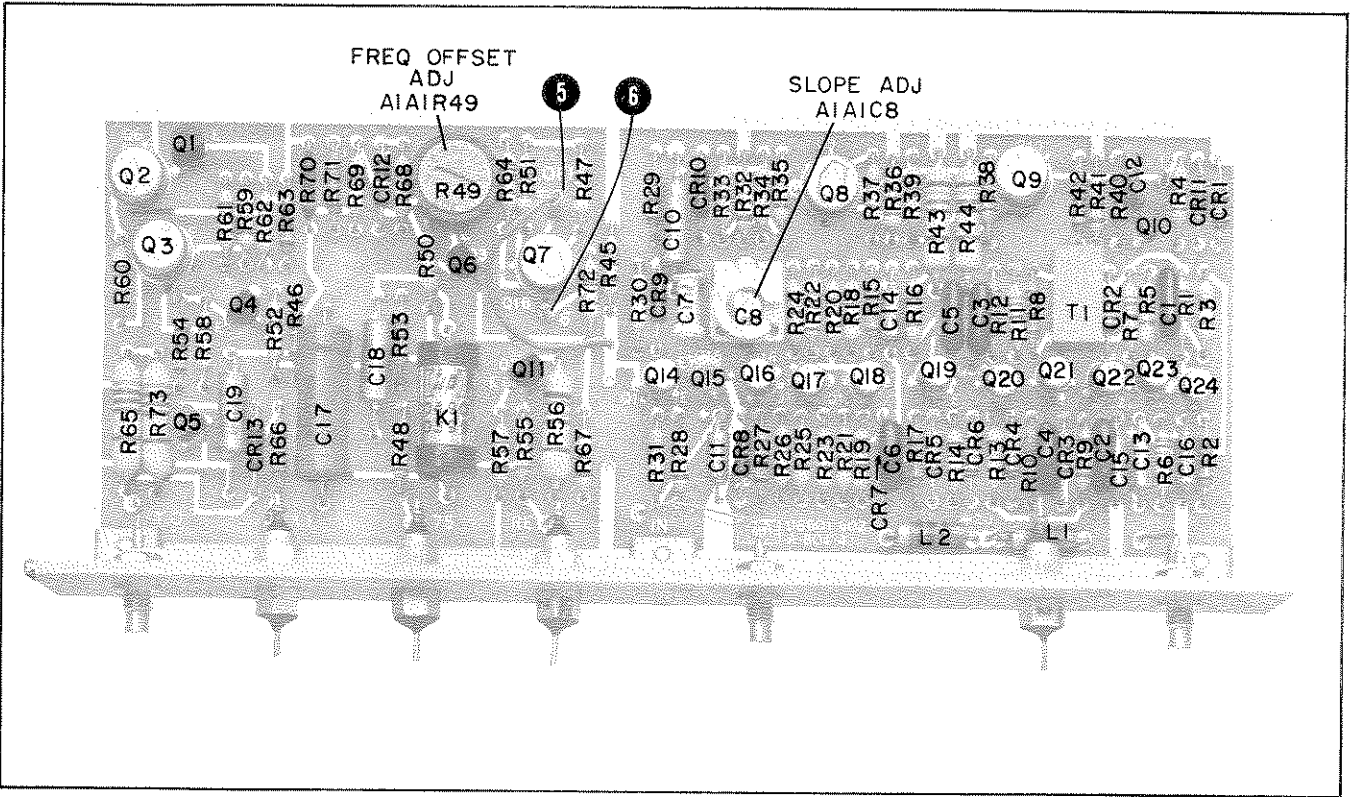

Figure 7-9. Component Identification, A1A1 Discriminator Assembly
(Part of Change 10)

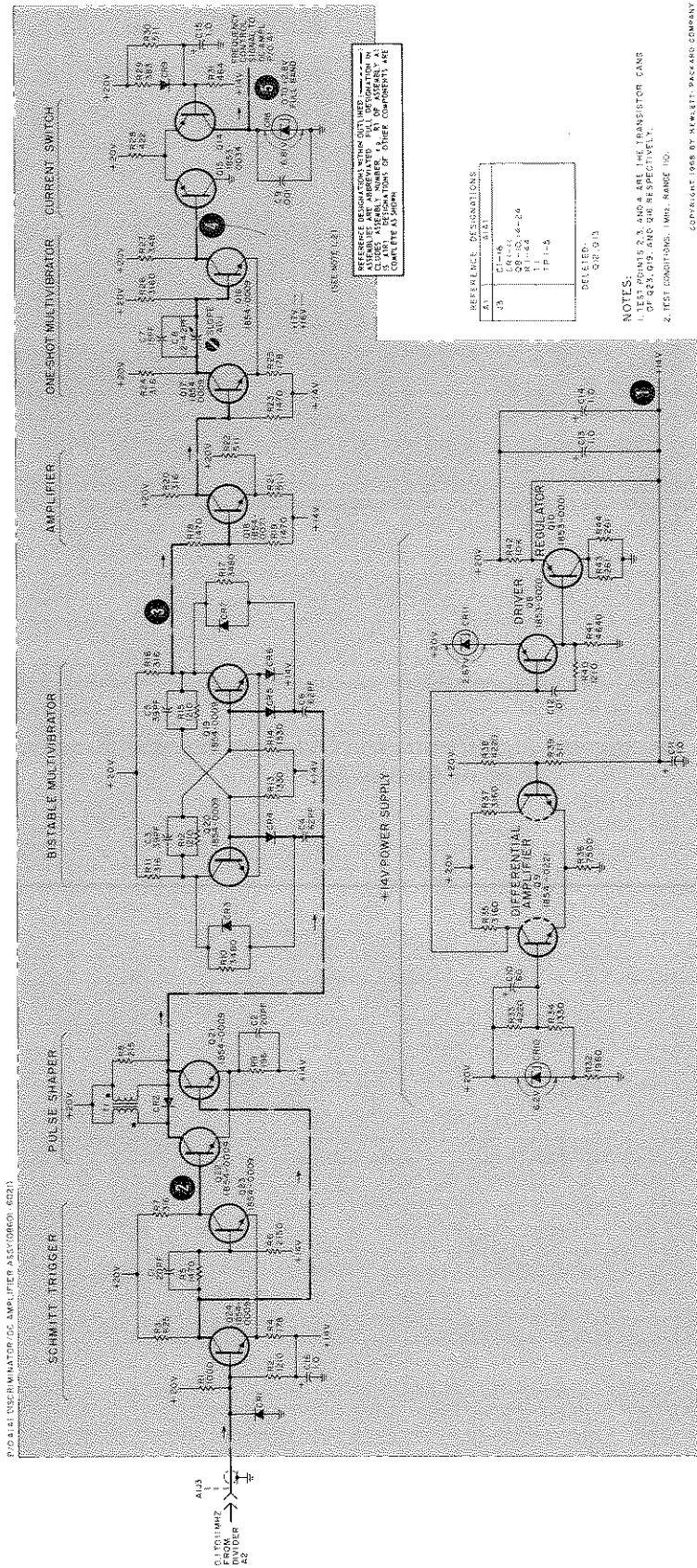

Figure 7-10. A1A1 Discriminator Circuit, Schematic Diagram (Part of Change 10)

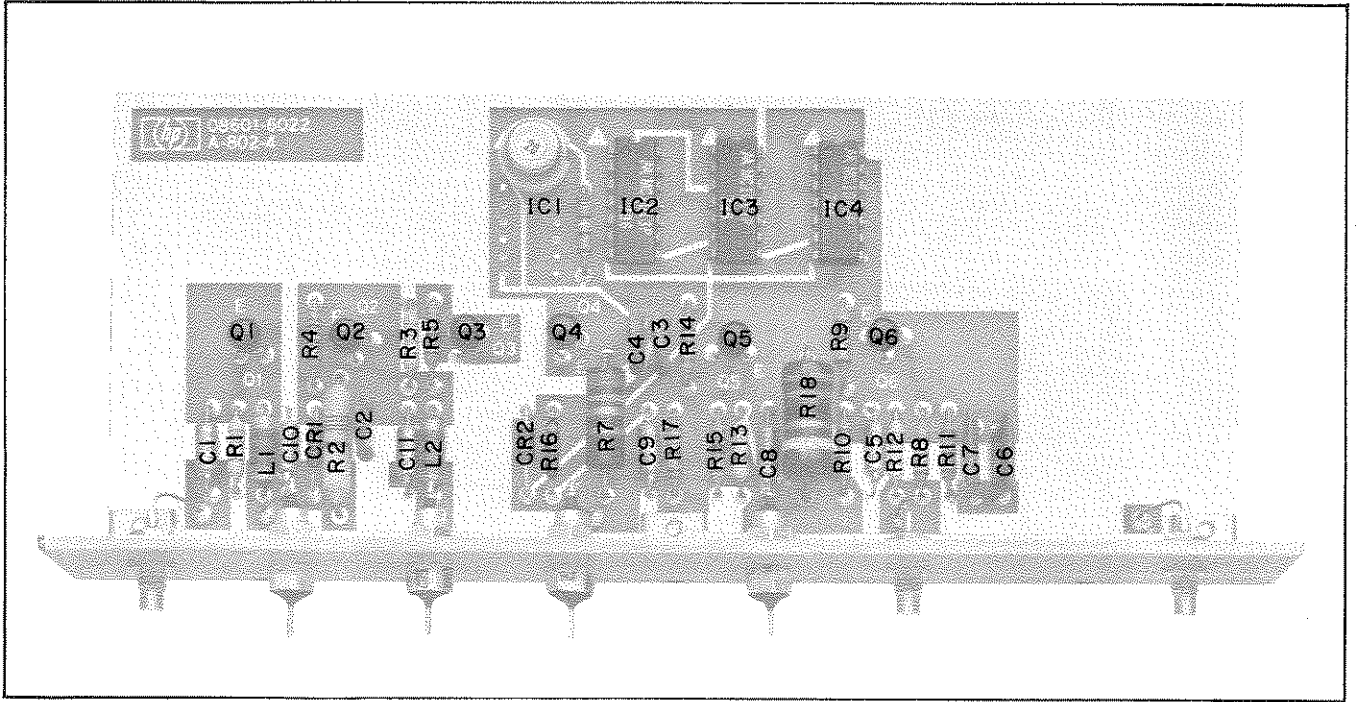

Figure 7-11. Component Identification, A2 Divider Assembly
(Part of Change 10)

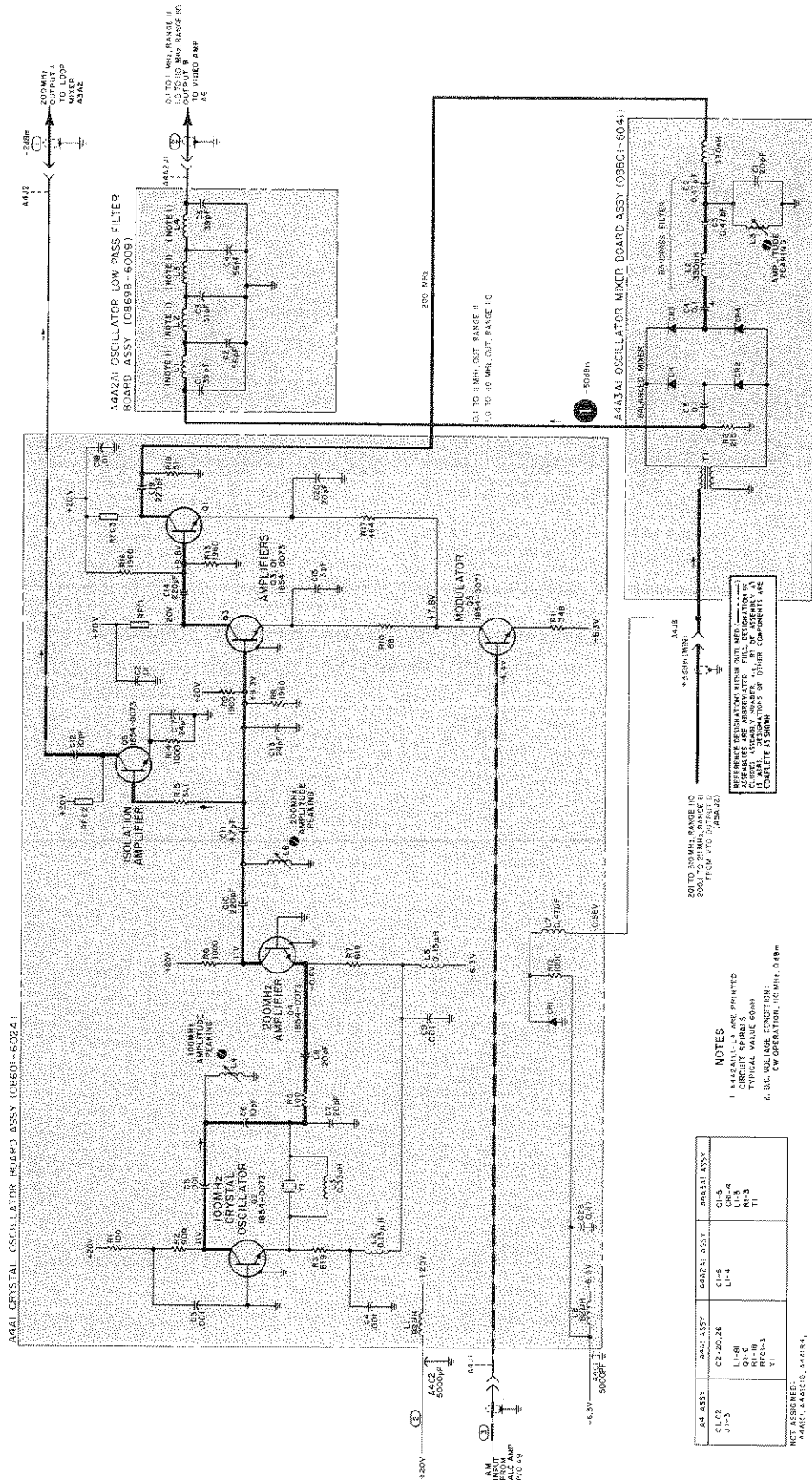
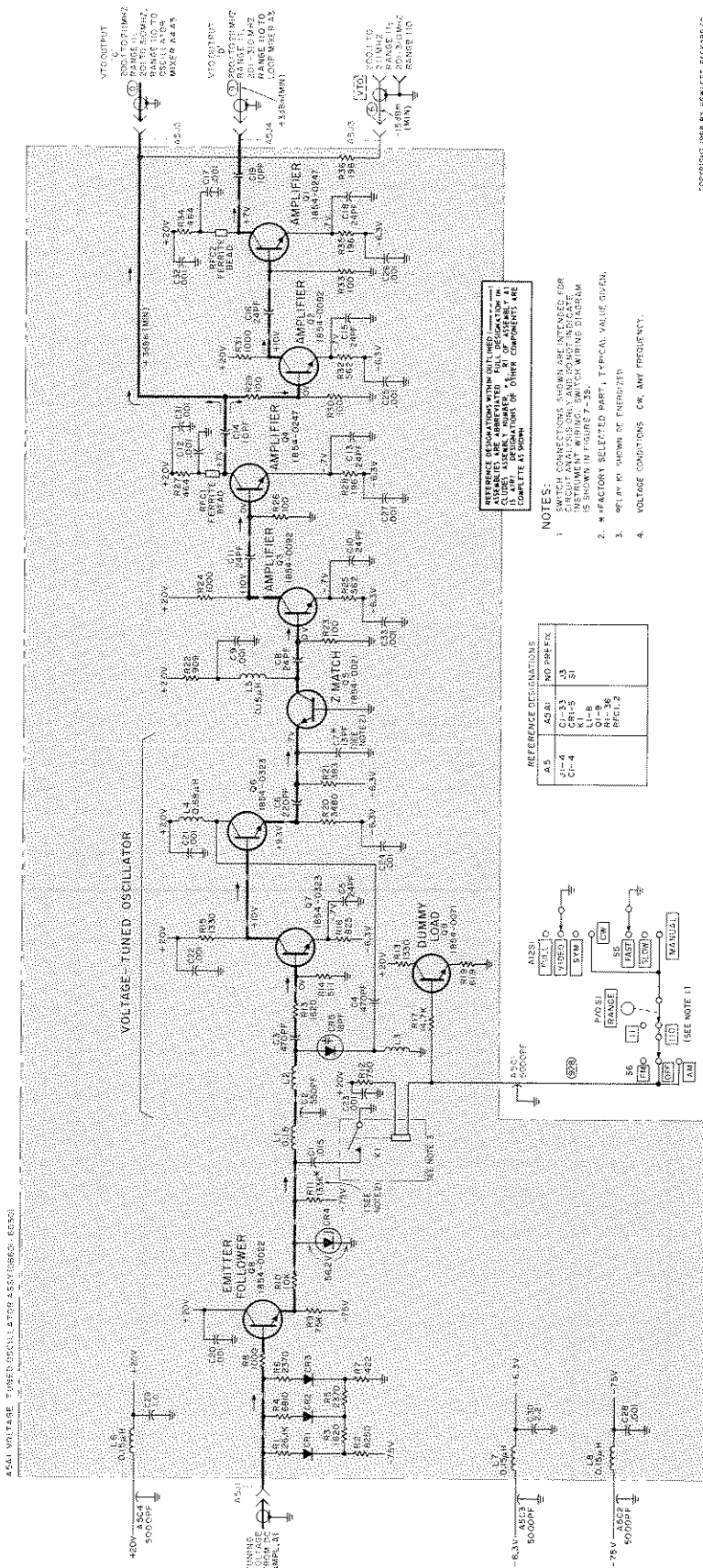

Figure 7-16. A4 Crystal Oscillator Assembly, Schematic Diagram (Part of Change 10)



ALL PARTS SHOWN WITH DIMENSIONS UNLESS OTHERWISE SPECIFIED. DIMENSIONS IN PARENTHESES ARE TYPICAL. DIMENSIONS IN SQUARE BRACKETS ARE FOR OTHER TYPES OF COMPONENTS. DIMENSIONS IN SQUARE BRACKETS ARE FOR OTHER TYPES OF COMPONENTS. DIMENSIONS IN SQUARE BRACKETS ARE FOR OTHER TYPES OF COMPONENTS.

- NOTES:
1. DIMENSIONS IN SQUARE BRACKETS ARE FOR OTHER TYPES OF COMPONENTS. DIMENSIONS IN SQUARE BRACKETS ARE FOR OTHER TYPES OF COMPONENTS.
 2. DIMENSIONS IN SQUARE BRACKETS ARE FOR OTHER TYPES OF COMPONENTS. DIMENSIONS IN SQUARE BRACKETS ARE FOR OTHER TYPES OF COMPONENTS.
 3. DIMENSIONS IN SQUARE BRACKETS ARE FOR OTHER TYPES OF COMPONENTS. DIMENSIONS IN SQUARE BRACKETS ARE FOR OTHER TYPES OF COMPONENTS.
 4. DIMENSIONS IN SQUARE BRACKETS ARE FOR OTHER TYPES OF COMPONENTS. DIMENSIONS IN SQUARE BRACKETS ARE FOR OTHER TYPES OF COMPONENTS.

REFERENCE DESIGNATIONS

A5	AGAL	NO BREAK
2-4	C1-33	J3
4	K1-5	S1
	Q1-8	
	R1-36	
	W1-2	

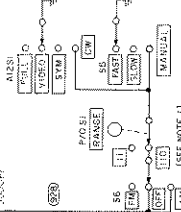

CONDUCTOR: 988 BY HEWLETT-PACKARD CO.
 988A-VOL-TUNE-8601A

Figure 7-18. A5 VTO Assembly, Schematic Diagram (Part of Change 10)

Table 7-3. A2 Assy Replaceable Parts
(Part of Change 10)

Reference Designation	HP Part Number	Qty	Description	Mfr Code	Mfr Part Number
A2	08601-6002	1	DIVIDER ASSY	28480	08601-6002
A2			INCL C1-C4, J1-J3, A2A1 ASSY & COVER		
A2C1	0160-2049	4	C:FXD CER FEED-THRU 5000 PF +80-20%	28480	0160-2049
A2C2	0160-2049		C:FXD CER FEED-THRU 5000 PF +80-20%	28480	0160-2049
A2C3	0160-2049		C:FXD CER FEED-THRU 5000 PF +80-20%	28480	0160-2049
A2C4	0160-2049		C:FXD CER FEED-THRU 5000 PF +80-20%	28480	0160-2049
A2J1	1250-0829	3	CONNECTOR:RF 50-OHM SCREW ON TYPE	98291	50-045-4610
A2J2	1250-0829		CONNECTOR:RF 50-OHM SCREW ON TYPE	98291	50-045-4610
A2J3	1250-0829		CONNECTOR:RF 50-OHM SCREW ON TYPE	98291	50-045-4610
A2Z	0160-0084	1	BRAID:RF	12881	10-541
A2Z	08698-0012	1	GASKET:RFI	28480	08698-0012
A2Z	08601-2016	1	COVER	28480	08601-2016
A2A1	08601-6022	1	BOARD ASSY:DIVIDER	28480	08601-6022
A2A1C1	0180-0197	5	C:FXD ELECT 2.2 UF 10% 20VDCW	56289	150D225X9020A2-DYS
A2A1C2	0160-2930	5	C:FXD CER 0.01 UF +80-20% 100VDCW	91418	TA
A2A1C3	0160-2930		C:FXD CER 0.01 UF +80-20% 100VDCW	91418	TA
A2A1C4	0160-2930		C:FXD CER 0.01 UF +80-20% 100VDCW	91418	TA
A2A1C5	0180-0197		C:FXD ELECT 2.2 UF 10% 20VDCW	56289	150D225X9020A2-DYS
A2A1C6	0150-0121	2	C:FXD CER 0.1 UF +80-20% 50VDCW	56289	5C50BIS-CML
A2A1C7	0150-0121		C:FXD CER 0.1 UF +80-20% 50VDCW	56289	5C50BIS-CML
A2A1C8	0180-0197		C:FXD ELECT 2.2 UF 10% 20VDCW	56289	150D225X9020A2-DYS
A2A1C9	0180-0197		C:FXD ELECT 2.2 UF 10% 20VDCW	56289	150D225X9020A2-DYS
A2A1C10	0180-0291	1	C:FXD ELECT 1.0 UF 10% 35VDCW	56289	150D105X9035A2-DYS
A2A1C11	0180-0197		C:FXD ELECT 2.2 UF 10% 20VDCW	56289	150D225X9020A2-DYS
A2A1CR1	1902-3070	1	DIODE:BREAKDOWN 4.22V 5%	04713	S210939-74
A2A1CR2	1902-0579	1	DIODE BREAKDOWN:5.11V	28480	1902-0579
A2A1IC1	1820-0101	1	INTEGRATED CIRCUIT:DIFFERENTIAL AMPL	04713	MC1034P
A2A1IC2	1820-0102	3	INTEGRATED CIRCUIT:J-K FLIP FLOP	04713	MC1013P
A2A1IC3	1820-0102		INTEGRATED CIRCUIT:J-K FLIP FLOP	04713	MC1013P
A2A1IC4	1820-0102		INTEGRATED CIRCUIT:J-K FLIP FLOP	04713	MC1013P
A2A1L1	9140-0178	2	COIL:FXD 12 UH 10%	28480	9140-0178
A2A1L2	9140-0178		COIL:FXD 12 UH 10%	28480	9140-0178
A2A1Q1	1853-0015	2	TSTR:SI PNP	80131	2N3640
A2A1Q2	1853-0015		TSTR:SI PNP	80131	2N3640
A2A1Q3	1854-0092	4	TSTR:SI NPN	80131	2N3563
A2A1Q4	1854-0092		TSTR:SI NPN	80131	2N3563
A2A1Q5	1854-0092		TSTR:SI NPN	80131	2N3563
A2A1Q6	1854-0092		TSTR:SI NPN	80131	2N3563
A2A1R1	0757-0394	6	R:FXD MET FLM 51.1 OHM 1% 1/8W	28480	0757-0394
A2A1R2	0757-0821	1	R:FXD MET FLM 1.21K OHM 1% 1/2W	28480	0757-0821
A2A1R3	0757-0394		R:FXD MET FLM 51.1 OHM 1% 1/8W	28480	0757-0394
A2A1R4	0698-3441	2	R:FXD MET FLM 215 OHM 1% 1/8W	28480	0698-3441
A2A1R5	0757-0420	3	R:FXD MET FLM 750 OHM 1% 1/8W	28480	0757-0420
A2A1R6			NOT ASSIGNED		
A2A1R7	0811-1675	1	R:FXD WH 5.6 OHM 5% 2W	28480	0811-1675
A2A1R8	0757-0418		R:FXD MET FLM 619 OHM 1% 1/8W	28480	0757-0418
A2A1R9	0757-0346	3	R:FXD MET FLM 10 OHM 1% 1/8W	28480	0757-0346
A2A1R10	0698-3441		R:FXD MET FLM 215 OHM 1% 1/8W	28480	0698-3441
A2A1R11	0698-3443	2	R:FXD MET FLM 287 OHM 1% 1/8W	28480	0698-3443
A2A1R12	0757-0394		R:FXD MET FLM 51.1 OHM 1% 1/8W	28480	0757-0394
A2A1R13	0757-1094	1	R:FXD MET FLM 1.47K OHM 1% 1/8W	28480	0757-1094
A2A1R14	0757-0420		R:FXD MET FLM 750 OHM 1% 1/8W	28480	0757-0420
A2A1R15	0757-0420		R:FXD MET FLM 750 OHM 1% 1/8W	28480	0757-0420
A2A1R16	0698-3431	1	R:FXD MET FLM 23.7 OHM 1% 1/8W	28480	0698-3431
A2A1R17	0698-3443		R:FXD MET FLM 287 OHM 1% 1/8W	28480	0698-3443
A2A1R18	0764-0033	1	R:FXD MET OX 33 OHM 5% 2W	28480	0764-0033

See introduction to this section for ordering information

Table 7-4. A4A1 Assy Replaceable Parts
(Part of Change 10)

Reference Designation	HP Part Number	Qty	Description	Mfr Code	Mfr Part Number
A4A1	08601-6024	1	BOARD ASSY:FIXED OSCILLATOR	28480	08601-6024
A4A1C1			NOT ASSIGNED		
A4A1C2	0160-2930		C:FXD CER 0.01 UF +80-20% 100VDCW	91418	TA
A4A1C3	0150-0050	4	C:FXD CER 1000 PF +80-20% 1000VDCW	56289	C067B102E102Z526-CDH
A4A1C4	0150-0050		C:FXD CER 1000 PF +80-20% 1000VDCW	56289	C067B102E102Z526-CDH
A4A1C5	0150-0050		C:FXD CER 1000 PF +80-20% 1000VDCW	56289	C067B102E102Z526-CDH
A4A1C6	0160-2257	2	C:FXD CER 10 PF 5% 500VDCW	72982	301-000-COHO-100J
A4A1C7	0160-2264	4	C:FXD CER 20 PF 5% 500VDCW	72982	301-000-COHO-200J
A4A1C8	0160-2264		C:FXD CER 20 PF 5% 500VDCW	72982	301-000-COHO-200J
A4A1C9	0150-0050		C:FXD CER 1000 PF +80-20% 1000VDCW	56289	C067B102E102Z526-CDH
A4A1C10	0160-2139	3	C:FXD CER 220 PF +80-20% 1000VDCW	91418	TYPE B
A4A1C11	0160-2249	1	C:FXD CER 4.7 PF 500VDCW	72982	301-NPD-4.7 PF
A4A1C12	0160-2257		C:FXD CER 10 PF 5% 500VDCW	72982	301-000-COHO-100J
A4A1C13	0160-2266	1	C:FXD CER 24 PF 5% 500VDCW	72982	301-000-COHO-240J
A4A1C14	0160-2139		C:FXD CER 220 PF +80-20% 1000VDCW	91418	TYPE B
A4A1C15	0160-2260	1	C:FXD CER 13 PF 5% 500VDCW	72982	301-000-COHO 130J
A4A1C16			NOT ASSIGNED		
A4A1C17	0160-2264		C:FXD CER 20 PF 5% 500VDCW	72982	301-000-COHO-200J
A4A1C18	0160-2930		C:FXD CER 0.01 UF +80-20% 100VDCW	91418	TA
A4A1C19	0160-2139		C:FXD CER 220 PF +80-20% 1000VDCW	91418	TYPE B
A4A1C20	0160-2264		C:FXD CER 20 PF 5% 500VDCW	72982	301-000-COHO-200J
A4A1C21	1901-0033	1	DIODE:SILICON 100MA 180V	07263	F03369
A4A1L2	9100-1610	2	COIL:MOLDED CHOKE 0.15 UH 20%	28480	9100-1610
A4A1L3	9100-1612	1	COIL:FXD RF 0.33 UH 20%	28480	9100-1612
A4A1L4	08698-6016	1	COIL:VAR 100MHZ	28480	08698-6016
A4A1L5	9100-1610		COIL:MOLDED CHOKE 0.15 UH 20%	28480	9100-1610
A4A1L6	08698-6015	1	COIL:VAR 200MHZ	28480	08698-6015
A4A1L7	9100-1613	1	COIL:FXD 0.47 UH 20%	28480	9100-1613
A4A1L8	9140-0238		COIL:FXD 82 UH 5%	28480	9140-0238
A4A1Q1	1854-0073	5	TSTR:SI NPN(SELECTED FROM 2N2857)	28480	1854-0073
A4A1Q2	1854-0073		TSTR:SI NPN(SELECTED FROM 2N2857)	28480	1854-0073
A4A1Q3	1854-0073		TSTR:SI NPN(SELECTED FROM 2N2857)	28480	1854-0073
A4A1Q4	1854-0073		TSTR:SI NPN(SELECTED FROM 2N2857)	28480	1854-0073
A4A1Q5	1854-0071	1	TSTR:SI NPN(SELECTED FROM 2N3704)	28480	1854-0071
A4A1Q6	1854-0073		TSTR:SI NPN(SELECTED FROM 2N2857)	28480	1854-0073
A4A1R1	0757-0401	2	R:FXD MET FLM 100 OHM 1% 1/8W	28480	0757-0401
A4A1R2	0757-0422	1	R:FXD MET FLM 909 OHM 1% 1/8W	28480	0757-0422
A4A1R3	0757-0418		R:FXD MET FLM 619 OHM 1% 1/8W	28480	0757-0418
A4A1R4			NOT ASSIGNED		
A4A1R5	0757-0401		R:FXD MET FLM 100 OHM 1% 1/8W	28480	0757-0401
A4A1R6	0757-0280	2	R:FXD MET FLM 1K OHM 1% 1/8W	28480	0757-0280
A4A1R7	0757-0418		R:FXD MET FLM 619 OHM 1% 1/8W	28480	0757-0418
A4A1R8	0698-0083	4	R:FXD MET FLM 1.96K OHM 1% 1/8W	28480	0698-0083
A4A1R9	0698-0083		R:FXD MET FLM 1.96K OHM 1% 1/8W	28480	0698-0083
A4A1R10	0757-0419	1	R:FXD MET FLM 681 OHM 1% 1/8W	28480	0757-0419
A4A1R11	0698-3445	1	R:FXD MET FLM 348 OHM 1% 1/8W	28480	0698-3445
A4A1R12	0757-0799	1	R:FXD MET FLM 121 OHM 1% 1/2W	28480	0757-0799
A4A1R13	0698-0083		R:FXD MET FLM 1.96K OHM 1% 1/8W	28480	0698-0083
A4A1R14	0757-0280		R:FXD MET FLM 1K OHM 1% 1/8W	28480	0757-0280
A4A1R15	0757-0394		R:FXD MET FLM 51.1 OHM 1% 1/8W	28480	0757-0394
A4A1R16	0698-0083		R:FXD MET FLM 1.96K OHM 1% 1/8W	28480	0698-0083
A4A1R17	0698-0090	1	R:FXD MET FLM 464 OHM 1% 1/2W	28480	0698-0090
A4A1R18	0757-0394		R:FXD MET FLM 51.1 OHM 1% 1/8W	28480	0757-0394
A4A1R19	0698-3440	1	R:FXD MET FLM 196 OHM 1% 1/8W	28480	0698-3440
A4A1R20	0757-0394		R:FXD MET FLM 51.1 OHM 1% 1/8W	28480	0757-0394
A4A1RFC1	9100-1788	3	COIL:CHOKE	02114	VK200-10/48
A4A1RFC2	9100-1788		COIL:CHOKE	02114	VK200-10/48
A4A1RFC3	9100-1788		COIL:CHOKE	02114	VK200-10/48
A4A1Y1	0410-0172	1	CRYSTAL:QUARTZ 100MHZ	28480	0410-0172
A4A2	08698-6029	1	OSC LOW PASS FILTER ASSY	28480	08698-6029
A4A2	08698-0005	1	CAN:FILTER	28480	08698-0005
A4A2	08698-0008	1	COVER:CAN	28480	08698-0008
A4A2J1	1250-0826	1	CONNECTOR:RF	98291	50-027-0000
A4A2A1	08698-6009	1	OSC & LOW PASS FILTER BD ASSY	28480	08698-6009
A4A2A1C1	0160-2200	2	C:FXD MICA 43 PF 5%	72136	RDM15E430J3C
A4A2A1C2	0140-0205	4	C:FXD MICA 62 PF 5%	28480	0140-0205
A4A2A1C3	0140-0205		C:FXD MICA 62 PF 5%	28480	0140-0205
A4A2A1C4	0140-0205		C:FXD MICA 62 PF 5%	28480	0140-0205
A4A2A1C5	0160-2200		C:FXD MICA 43 PF 5%	72136	RDM15E430J3C
A4A2A1L1			NSR, P/O BD ASSY, TYPICAL VALUE 60 NH		
A4A2A1L2			NSR, P/O BD ASSY, TYPICAL VALUE 60 NH		
A4A2A1L3			NSR, P/O BD ASSY, TYPICAL VALUE 60 NH		
A4A2A1L4			NSR, P/O BD ASSY, TYPICAL VALUE 60 NH		

See introduction to this section for ordering information

CHANGE 14

Table 6-2; Replaceable Parts:

Change A9E1 to HP Part Number 1820-0203.

CHANGE 15

Table 6-2; Replaceable Parts:

Change A9C11 to HP Part Number 0160-2146, C:FXD CER 0,02 UF +80 -20 10 VDCW.

Schematic Sheet 9; Figure 8-28; FREQUENCY CONTROL A9:

Change value of A9C11 to 0.02.

CHANGE 16**NOTE**

This change implements a different color scheme for the instrument. The old colors are no longer available but listed below for reference.

Table 6-2, Replaceable Parts:

Change HP Part No. 08601-00043 to 08601-0002 FRONT PANEL (LIGHT GRAY/BLACK) 8601A, 8601A OPT 003-010.

Change HP Part No. 4040-8905 to 4040-0328 BEZEL: BLACK METER.

Change HP Part No. 08601-00046 to 08601-0015 FRONT PANEL (LIGHT GRAY/BLACK) (8601A OPT 001, 002).

Change HP Part No. 08601-00045 to 08601-0025 FRONT PANEL (LIGHT GRAY/BLACK) (8601A OPT 011).

Change HP Part No. 08601-00044 to 08601-0006 TOP COVER (BLUE GRAY).

Change HP Part No. 5000-0567 to 5000-0704 SIDE COVER 6 X 16 (BLUE GRAY).

Change HP Part No. 5000-8535 to 5000-0136 BOTTOM COVER 7 X 16 (BLUE GRAY).

Change HP Part No. 08601-20089 to 08601-2004 PANEL READOUT (BLACK).

Change HP Part No. 08601-20091 to 08601-2011 METER TRIM: TOP (BLACK).

CHANGE 17

Table 6-2, Replaceable Parts:

Change A4A1R7 to HP Part No. 0698-3441, R: RXD MET FLM 215 OHM 1% 1/8W (FACTORY SELECTED PART).

Schematic Sheet 4; Figure 8-17; Crystal Oscillator A4A1:

Change value of A4A1R7* to 215.

CHANGE 18

Table 6-2, Replaceable Part:

Change A9R3* 10K to HP Part No. 0757-0443 R: FXD MET FLM 11.0K OHM 1% 1/8W (Not Factory Select).

Schematic Sheet 9; Figure 8-28; Frequency Control A9:

Change A9R3* 10K to A9R3 11K.

CHANGE 19

Table 5-2; Factory Selected Components:
Delete the following entry:

A5A1R12	Selected to obtain sufficient oscillator Frequency Range	5
---------	--	---

Table 6-2, Replaceable Parts:

Change A5A1Q1 and A5A1Q3 to HP Part No. 1854-0247. (HP Part No. 1854-0580 is the recommended replacement).

Change A5A1R12 to HP Part No. 0757-0470 162K OHM 1% 1/8W.

Schematic Sheet 5; Figure 8-19; Voltage-Tuned Oscillator A5A1.
Change A9R3* to A9R3 162K.

CHANGE 20

Table 6-2; Replaceable Parts:

Change A9R144 to HP Part No. 0698-3452, R:FXD 147K OHM 1% 1/8W.

Schematic Sheet 11; Figure 8-32; Frequency Control A9:
Change value of A9R144 to 147K.

CHANGE 21

Table 5-2; Factory Selected Components:
Delete the following entry:

A11R7	Selected to compensate for tolerance variation in A11R6	12
-------	---	----

Table 6-2; Replaceable Parts:

Change A11R7 to HP Part No. 0698-3156, R:FXD MET FLM 14.7K OHM 1% 1/8W.

Schematic Sheet 12; Figure 8-34; SYM SWEEP WIDTH A11:

Change A11R7* 14.3K to A11R7 14.7K.

CHANGE 22

Table 6-2, Replaceable Parts:

Change A3A1R14 to HP Part No. 0757-0422, R:FXD MET FLM 909 OHM 1% 1/8W.

Delete the following HP Part No. in the Miscellaneous section:

0360-0042, LUG GROUNDING
2360-0195, SCREW: POZI-DRIVE
2420-0001; NUT: HEX
2190-0007, WASHER: LOCK
08601-00050, NAME PLATE: 400 HZ MOD (OPTION 005).

Schematic Sheet 3; Figure 8-13; LOOP AMPLIFIER A3A1

Change A3A1R14* 1.1K to A3A1R14 909.

CHANGE 23

Table 6-2; Replaceable Parts:

Change A9R120 to HP Part No. 2100-1768 R:VAR CERMET 20 OHM 10%.

CHANGE 24

Table 1-1, Stability in CW:

Change first two lines of specification to read as follows:

100 ppm +1 kHz/10 min. high range after one-hour warmup.

100 ppm +100 Hz/10 min. Low range after one-hour warmup.

CHANGE 25

Table 6-2; Replaceable Parts:

Change A7 MP1 to HP Part No. 08601-0009 DIAL-KNOB ASSY: ATTENUATOR.

Change A11S1 to HP Part No. 08601-0010 DIAL-KNOB ASSY: SYM SWEEP WIDTH.

CHANGE 26

Table 6-2; Replaceable Parts:

Change A10A32 to HP Part No. 0757-0278, R:RFD MET FLM 1.78K OHM 1% 1/8W. Part No. 0757-0417 is the recommended replacement.

Schematic Sheet 8; Figure 8-26; Power Supply A10:

Change value of A10R32 to 1780.

CHANGE 27

Table 6-2, Replaceable Parts:

Delete second and third A12 entries. (Options 001, 002, and 011).

Delete second A12C1 entry (Options 001, 002, and 011).

Schematic Sheet 12; Figure 8-34: CW/SWEEP SWITCH A12:

Delete notes 1 and 2 and the references to the notes.

CHANGE 28

Table 6-2; Replaceable Parts:

Change A9E1 to HP Part No. 1826-0013. Part No. 1826-0261 is a high reliability replacement for the 1826-0013.

CHANGE 29

Table 6-2; Replaceable Parts:

Change A9R178 to HP Part No. 0698-3631, R:FXD MET OX 330 OHM 5% 2W

Change A10R30 to HP Part No. 0811-1678, R: FXD WW 5.6 OHM 5% 2W.

Change first entry for S7 to HP Part No. 3101-1248.

Change the entry 2110-0470, FUSEHOLDER : under MISCELLANEOUS, to HP Part No. 1400-0084, FUSEHOLDER: EXTRACTOR POST TYPE.

Delete the entry 2110-0465, FUSEHOLDER: CAP under MISCELLANEOUS

Schematic Sheet 8: Figure 8-26; Power Supply A10:

Change the value of A10R30 to 10.

Change ac line power circuit as shown in the following partial schematic (Figure 7-19).

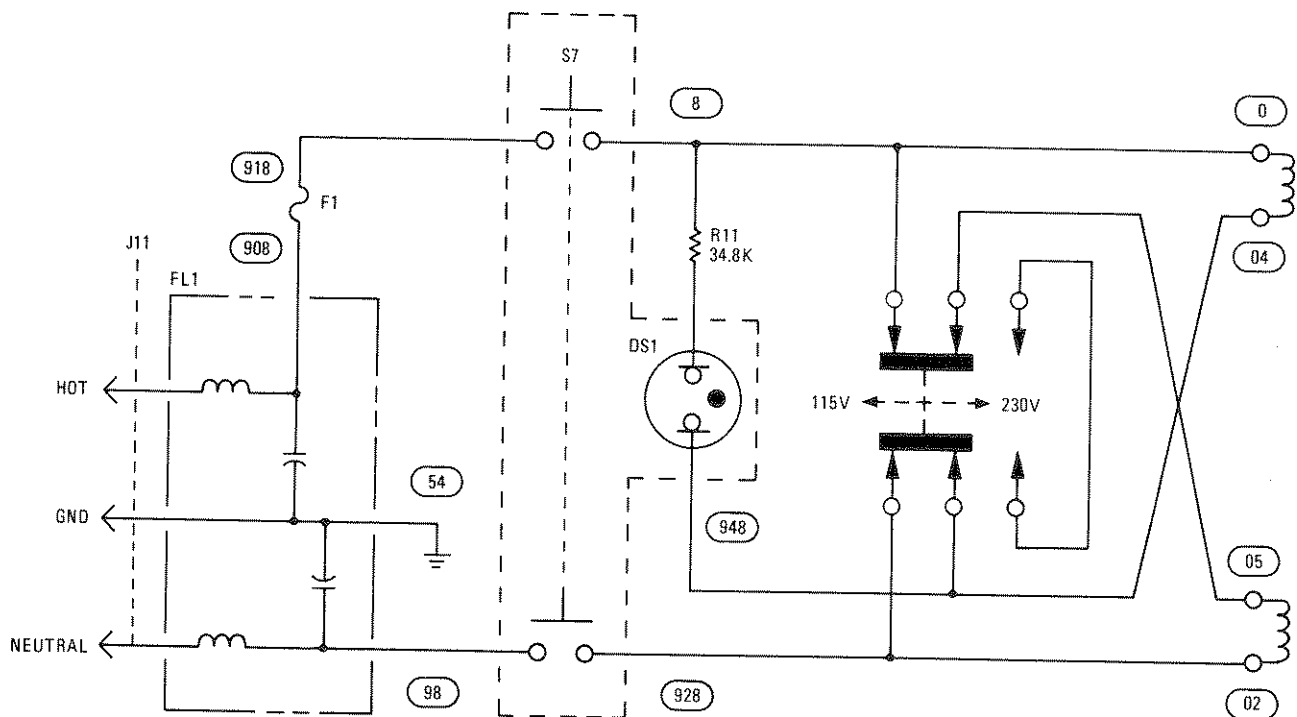

Figure 7-19. Primary Wiring Change (Change 29)

Schematic Sheet 11; Figure 8-32; Frequency Control A9:

Change the value of resistor A9R178 (left side of schematic) to 330.

CHANGE 30

Table 6-2; Replaceable Parts:

Change first entry for F1 to HP Part No. 2110-0202, FUSE 0.50A 250V SLOW-BLOW.

Change third entry for F1 to HP Part No. 2110-0312, FUSE CARTRIDGE 1 AMP 250V SLOW BLOW.

CHANGE 31

Table 6-2, Replaceable Part:

Change A9C41 to HP Part No. 0160-2917, C:FXD CER 0.05 UF +80 -20% 100 VDCW.

Change A9R24 to HP Part No. 2100-1772, R:VAR WW 500 OHM 5% TYPE H 1W.

Change A9R34 to HP Part No. 2100-1775, R:VAR WW 5K OHM 5% TYE H 1W.

Change A9R88 to HP Part No. 2100-1768, R:VAR WW 220 OHM 5% TYPE H 1W.

Change A9R95 to HP Part No. 2100-1775, R:VAR WW SK OHM 5% TYPE H 1W.

Change A9R117 to HP Part No. 2100-1768, R:VAR WW 50 OHM 5% TYPE H 1W.

Delete the A9R130 entry.

Change A9R131 to HP Part No. 2100-1777, R:VAR WW 20K OHM 5% TYPE H 1W.

Change A9R136 to HP Part No. 2100-1777, R:VAR WW 20K OHM 5% TYPE H 1W.

Change A9R160 to HP Part No. 2100-1776, R:VAR WW 10K OHM 5% TYPE H 1W.

Change A9R162 to HP Part No. 2100-1776, R:VAR WW 10K OHM 5% TYPE H 1W.

Change A9R181 to HP Part No. 2100-1777, R:VAR WW 20K OHM 5% TYPE H 1W.

CHANGE 32

Table 6-2, Replaceable Parts:

Change A8F1 to HP Part No. 2110-0006, FUSE: CARTRIDGE 2 AMP 125V SLOW-BLOW.

Schematic Sheet 8: Figure 8-26; Rectifier A8:

Change the value of A8F1 to 2A.

CHANGE 33

Table 6-2, Replaceable Parts:

Change A9C10 to Hp Part No. 0160-2146, C:FXD CER 0.02 UF +80 -20% 100 VDCW.

Change A9C36 to HP Part No. 0160-2146, C:FXD CER 0.02 UF +80 -20% 100 VDCW.

Schematic Sheet 9, Figure 8-28, Frequency Control A9:

Change value of A9C10 to 0.02.

Schematic Sheet 11, Figure 8-32, Frequency Control A9:

Change value of A9C36 to 0.02.

CHANGE 34

Table 6-2, Replaceable Parts:

Substitute Table 7-5 for the A2 DIVIDER ASSY Replaceable Parts List.

Schematic Sheet 2:

Substitute Figure 7-20 for Figure 8-9.

Substitute Figure 7-21 for Figure 8-10.

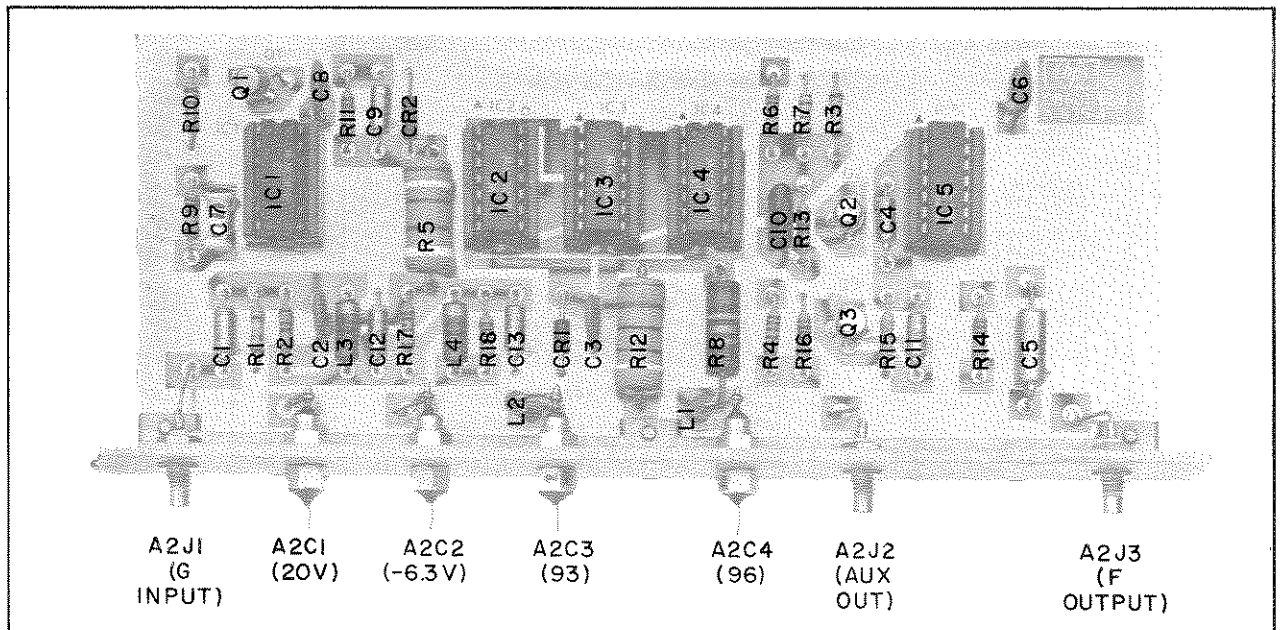

Figure 7-20. A2 Divider/Divider Bypass, Component Identification (Serial Prefixed 912- thru 945-)

CHANGE 35

Table 6-2, Replaceable Parts:

Change A1A1Q1 and A1A1Q3 to HP Part No. 1853-0012,

Change R11 to HP Part No. 0757-3162, R:FXD MET FLM 46.4K OHM 1% 1/8W.

Schematic Sheet 8, Figure 8-26:

Change R11 value to 34.8K.

Table 6-2. Replaceable Parts

Reference Designation	HP Part Number	Qty	Description	Mfr Code	Mfr Part Number
A2	08601-2028	1	FRONT PANEL:DIVIDER ASSY	28480	08601-2028
A2	08601-2016	2	BOX:SHIELD	28480	08601-2016
A2C1	0160-2049		C:FXD CER 5000 PF 80/20%	28480	0160-2049
A2C2	0160-2049		C:FXD CER 5000 PF 80/20%	28480	0160-2049
A2C3	0160-2049		C:FXD CER 5000 PF 80/20%	28480	0160-2049
A2C4	0160-2049		C:FXD CER 5000 PF 80/20%	28480	0160-2049
A2J1	1250-0829		CONNECTOR:RF 50-OHM SCREW ON TYPE	98291	50-045-4610
A2J2	1250-0829		CONNECTOR:RF 50-OHM SCREW ON TYPE	98291	50-045-4610
A2J3	1250-0829		CONNECTOR:RF 50-OHM SCREW ON TYPE	98291	50-045-4610
A2A1	08601-6043	1	BOARD ASSY:DIVIDER	28480	08601-6043
A2A1C1	0180-0197		C:FXD ELECT 2.2 UF 10% 20VDCW	56289	150D225X9020A2-DYS
A2A1C2	0160-2055		C:FXD CER 0.01 UF +80-20% 100VDCW	56289	C023F101F103ZS22-CDH
A2A1C3	0160-2055		C:FXD CER 0.01 UF +80-20% 100VDCW	56289	C023F101F103ZS22-CDH
A2A1C4	0180-0197		C:FXD ELECT 2.2 UF 10% 20VDCW	56289	150D225X9020A2-DYS
A2A1C5	0180-0374		C:FXD TANT. 10 UF 10% 20VDCW	56289	150D136X9020B2-DYS
A2A1C6	0160-2055		C:FXD CER 0.01 UF +80-20% 100VDCW	56289	C023F101F103ZS22-CDH
A2A1C7			NOT ASSIGNED		
A2A1C8	0160-2055		C:FXD CER 0.01 UF +80-20% 100VDCW	56289	C023F101F103ZS22-CDH
A2A1C9	0180-0197		C:FXD ELECT 2.2 UF 10% 20VDCW	56289	150D225X9020A2-DYS
A2A1C10	0140-0198	1	C:FXD MICA 200 PF 5%	72136	RDML5F201J3C
A2A1C11	0180-0197		C:FXD ELECT 2.2 UF 10% 20VDCW	56289	150D225X9020A2-DYS
A2A1C12	0180-0291		C:FXD ELECT 1.0 UF 10% 35VDCW	56289	150D105X9035A2-DYS
A2A1C13	0180-0197		C:FXD ELECT 2.2 UF 10% 20VDCW	56289	150D225X9020A2-DYS
A2A1C14	0180-0197		C:FXD ELECT 2.2 UF 10% 20VDCW	56289	150D225X9020A2-DYS
A2A1C15	0180-0197		C:FXD ELECT 2.2 UF 10% 20VDCW	56289	150D225X9020A2-DYS
A2A1CR1	1902-0579	1	DIODE BREAKDOWN:5.11V	28480	1902-0579
A2A1CR2	1902-0041	1	DIODE:BREAKDOWN 5.11V 5%	04713	SZ10939-98
A2A1IC1	1820-0101	1	INTEGRATED CIRCUIT:DIFFERENTIAL AMPL	04713	MC1034P
A2A1IC2	1820-0102	3	INTEGRATED CIRCUIT:J-K FLIP FLOP	04713	MC1013P
A2A1IC3	1820-0102		INTEGRATED CIRCUIT:J-K FLIP FLOP	04713	MC1013P
A2A1IC4	1820-0102	1	INTEGRATED CIRCUIT:J-K FLIP FLOP	04713	MC1013P
A2A1IC5	1820-0387	1	INTEGRATED CIRCUIT	28480	1820-0387
A2A1L1	9100-1624	1	COIL/CHOKE 30 UH 5%	82142	15-4465-J
A2A1L2	9100-1618		COIL:MOLDED CHOKE 5.60 UH	28480	9100-1618
A2A1L3	9140-0237		COIL:FXD 200 UH 5%	28480	9140-0237
A2A1L4	9140-0237		COIL:FXD 200 UH 5%	28480	9140-0237
A2A1L5	9140-0158	5	COIL:FXD RF 1 UH 10%	99800	1025-20
A2A1Q1	1853-0034	2	TSTR:SI PNP(SELECTED FROM 2N3251)	28480	1853-0034
A2A1Q2	1853-0034		TSTR:SI PNP(SELECTED FROM 2N3251)	28480	1853-0034
A2A1Q3	1854-0345		TSTR:SI PNP	80131	2N5179
A2A1R1	0757-0399	2	R:FXD MET FLM 82.5 OHM 1% 1/8W	28480	0757-0399
A2A1R2	0698-3444	3	R:FXD MET FLM 316 OHM 1% 1/8W	28480	0698-3444
A2A1R3	0698-3432	3	R:FXD MET FLM 26.1 OHM 1% 1/8W	28480	0698-3432
A2A1R4	0698-3441	8	R:FXD MET FLM 215 OHM 1% 1/8W	28480	0698-3441
A2A1R5	0698-3629	1	R:FXD MET OX 270 OHM 5% 2W	28480	0698-3629
A2A1R6	0757-0280		R:FXD MET FLM 1K OHM 1% 1/8W	28480	0757-0280
A2A1R7	0698-3444		R:FXD MET FLM 316 OHM 1% 1/8W	28480	0698-3444
A2A1R8	0811-1675	1	R:FXD WW 5.6 OHM 5% 2W	28480	0811-1675
A2A1R9	0757-0280		R:FXD MET FLM 1K OHM 1% 1/8W	28480	0757-0280
A2A1R10	0698-3432		R:FXD MET FLM 26.1 OHM 1% 1/8W	28480	0698-3432
A2A1R11	0698-3441		R:FXD MET FLM 215 OHM 1% 1/8W	28480	0698-3441
A2A1R12			NOT ASSIGNED		
A2A1R13	0757-0280		R:FXD MET FLM 1K OHM 1% 1/8W	28480	0757-0280
A2A1R14	0757-0401		R:FXD MET FLM 100 OHM 1% 1/8W	28480	0757-0401
A2A1R15	0757-0346		R:FXD MET FLM 10 OHM 1% 1/8W	28480	0757-0346
A2A1R16			NOT ASSIGNED		
A2A1R17	0757-0280		R:FXD MET FLM 1K OHM 1% 1/8W	28480	0757-0280
A2A1R18	0757-0280		R:FXD MET FLM 1K OHM 1% 1/8W	28480	0757-0280
A2A1R19	0757-0442		R:FXD MET FLM 10.0K OHM 1% 1/8W	28480	0757-0442

See introduction to this section for ordering information